

Induced Flow Fans

- direct driven
- belt driven



AMCA 260 Tested!

Air in Motion.
Wolter Fans.

R10.4

wolter 

Content.....	1
Technical Description.....	2~9
Role.....	3
Products and Performance.....	3
Fume Jet Nozzles.....	3
Dispersion Height.....	3
Casing.....	4
Impellers.....	4
Fan Base and Support.....	4
Drive.....	4
Motor.....	4
Standard Colours.....	4
Ancillary Equipment.....	4
Service.....	4
Fan Type Code.....	5
AMCA Induced Flow Licensed.....	5
Quality, Testing and Certification.....	5
AMCA 260 Air Test Procedure.....	6
Performance Curves.....	6
Sound Levels.....	7
Laboratory Exhaust System.....	8
Effective Plume Height Calculation.....	9
Pressure Loss and Effective Plume Height Selection.....	9
Performance Curve.....	10~22
Pressure Loss.....	23~24
Plume Rise.....	25~27
Plenum Layout System.....	28~29
Nozzle Dimension.....	30~32

Subject to change without prior notice.



Figure 1



Figure 2

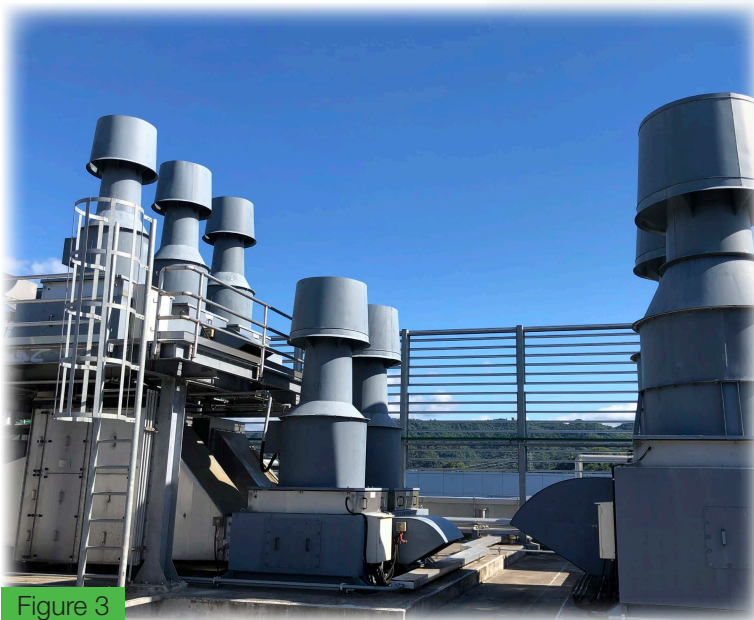
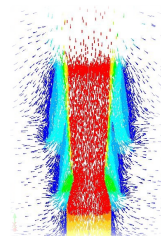

Figure 3

- › High Plume / Induced Flow Fan ensures high efficiency and reliability in dispersion of fumes.
- › Designers and engineers to specify the required dispersion height.
- › To prevent the plume down wash and limit exposure level that may be detrimental to the health.
- › Suitable for use in hospitals, schools, waste treatment plants, restaurants, test and research laboratories etc.

• Figure 1 - Conventional stack • Figure 2 - Wolter fume jet system • Figure 3 - Fume Jet SE30





Role

Wolter's CHEMCO with over 30 years of manufacturing experience has become one of the world's leading Chemical Resistant Plastic Fan and Ventilator manufacturers.

The years of experience and know-how in the areas of fan engineering and its designing capabilities enable Wolter's CHEMCO to develop a complete range of both steel and plastic induced flow fan with axial, centrifugal or mixed flow impellers with high efficient fume jet dispersion stack.

Products and Performance

Wolter offers a complete range of high-quality induced flow fan with either centrifugal or mixed flow impellers for superior performance.

With recent technical improvements, the induced flow fan now incorporates an "extended diffuser mixed-flow effect (EDME)" impeller design that offers a non-overloading power characteristic, higher efficiencies, good aerodynamic performance and lower noise emissions.

The PF-WMX series of fans impellers are extremely reliable, ensuring maintenance-free operation as well as excellent corrosion resistance.

Different materials i.e. Stainless steel, epoxy coated steel and thermo plastics materials can be processed in order to meet the demands of a multitude applications in the chemical industry and to convey different types of process air or gases. All fans are tested and rated in accordance with ISO 5801, AMCA 210, AMCA 260 and AMCA 300.

Fume Jet Nozzles

The Fume Jet nozzles are characterized by a vertical taper nozzle mounted which is mounted on the fan housing outlet for dispersion of fumes to the atmosphere to prevent the contamination from settling and plugging.

The Fume Jet nozzle is extremely rigid to ensure that it is free of vibration or drumming during operation. It is developed to give low noise level and trouble-free service.

The nozzles come with 2 series. The "SE" series of single wind-band offer significant entrainment with low pressure losses. The "HE" series of single and double wind-band design offers superior higher plume and entrainment capability. Each series comes with 13 difference sizes capable of handling airflows up to 91,000 cmh, static pressure up to 2,200 Pa and dispersion height up to 35 meter at 16 km/hr or 10 mph wind speed.

The wind-band is designed to induce draft by up to 270 ~ 300% of the exhaust flow volume.

The Fume Jet nozzle is also designed to provide adequate exit velocities that will help prevent plume downwash. Usually it is 1.5 times the maximum expected wind speed at the nozzle exit (U.S. EPA, 1985).

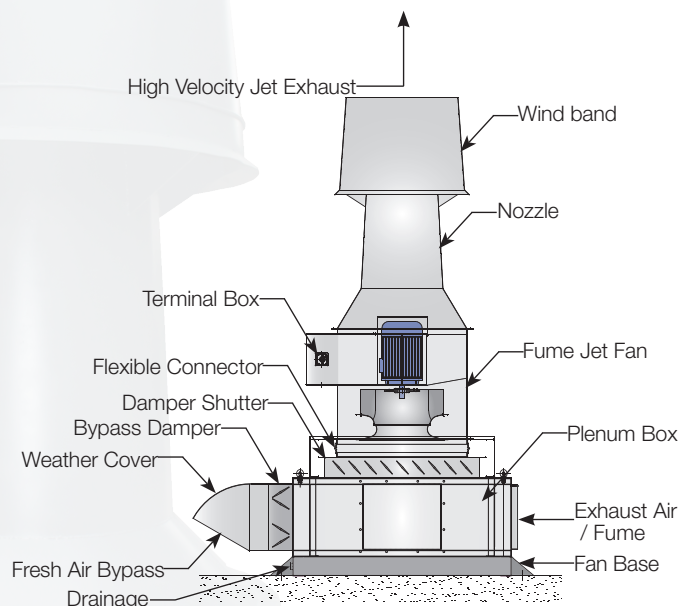

Dispersion Height

The flow rate, the minimum nozzle velocity and the wind speed determine the dispersion height. The wind dictates the speed and direction in which the bulk of the plume moves, and wind also affects the amount of dispersion that takes place.

The height to ensure that emissions do not result in excessive concentrations of the pollutant can be referred to (GEP) in 40 CFR 51 Section.

Casing

The Fan casing is either made of PP, PE, PVC, PVDF, GRP, epoxy coated galvanized steel or stainless steels and offers superior corrosion & UV resistance quality.

Impellers

Wolter's induced flow fan of "EDME" centrifugal impeller design has a non-overloading power characteristic capable of achieving better efficiencies, higher pressure and lower noise emissions over both the conventional mixed flow and centrifugal types of impeller.

Depending on the type of application, these impellers can be constructed of stainless steel, high-grade steel or aluminum alloy with epoxy coated for high temperature and anti corrosive resistance.

For adverse chemical resistance application, materials such as PA, PC, PVC, PVDF or GRP are used.

For flame-retardant properties, special reinforced compound materials with UV durability or protection against electrostatic discharge are used as well.

Each impeller is statically and dynamically balanced in two planes in accordance with Q2.5 of VDI 2060. All impellers are balanced to ANSI/AMCA Standard 204-05 BV level 4 standard, ISO 1940 & ISO 14694 international standards.

The impellers are designed for use with taper-bushes and are made of high-grade cast aluminum disks capable of running at high peripheral speeds.

Fan Base and Support

The supporting steel stands and fan bases are manufactured from heavy gauge mild steel and are hot-dip galvanised or epoxy powder coated to provide protection even in the most adverse conditions. Special surface treatments can be applied on request.

Drive

For Belt driven applications, precisely balanced pulleys with tension sleeve are used. All belts comply with ISO 1081:2013. The belt-drive and all other rotating parts are fitted with a protection guard.

Motor

If the application requires, motors of different protection classes can be supplied. On direct-driven fans, B5 flange-type motors are mounted. All motors are totally enclosed and air-cooled. Single-phase motors or motors with non-standard voltages can be supplied upon request.

Standard Colours

- › All PP fans - PANTONE Warm Grey 1C
- › All GRP fans - PANTONE 430

If required, other colors can be supplied.

Ancillary Equipment

- › Spring anti-vibration mounts
- › Condensate drain plug
- › Fan and motor support base frame
- › Shaft and bearing cover
- › Inlet flanges, flexible connections with clamps
- › Splinter shield

Service

Wolter's CHEMCO always strive to offer the best "value for money" and to maintain its primary objective of ensuring that all our products are safe, easy to use, whilst offering reliable quality with the latest in design technology, incorporating all useful and practical features, leaving the customers with superior products and service.



Technical Description



Dongguan Wolter Chemco Ventilation Ltd. certifies that the Series PF-WMX-SE30 and PF-WMX-HE50 shown herein are licensed to bear the AMCA Seal. The ratings shown are based on tests and procedures performed in accordance with AMCA Publication 211 and AMCA Publication 311 and comply with the requirements of the AMCA Certified Ratings Program.

The series PF-WMX-HDE90 is not licensed to bear the AMCA certified Ratings Seal.

Fan Type Code

PF-WMX - SE30 400

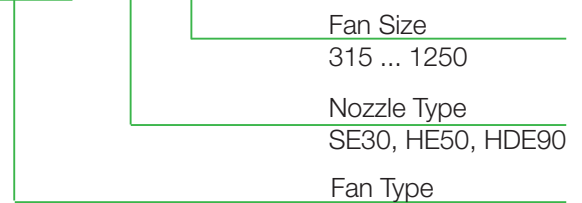

AMCA Induced Flow Licensed

The Air Movement and Control Association (AMCA) International, Inc. has introduced AMCA Standard 260, "Laboratory Methods of Testing Induced Flow Fans for Rating." Induced flow fans, also known as high plume dilution blowers, are used to dilute hazardous laboratory exhaust and disperse the exhaust high into the atmosphere, away from possible re-entrainment zones. AMCA Standard 260 can provide consulting and facility engineers independent performance verification for critical laboratory exhaust applications that they insist on for other fans and blowers used in general HVAC applications.

The AMCA Induced Flow Fan seal encompasses the following AMCA test standards:

- ▶ ANSI/AMCA Standard 210, "Laboratory Methods of Testing Fans for Certified Aerodynamic Performance Rating"
- ▶ AMCA Standard 260, "Laboratory Methods of Testing Induced Flow Fans for Rating"
- ▶ AMCA Standard 300, "Reverberant Room Method for Sound Testing of Fans"

Quality, Testing and Certification

The Fume Jets are produced to strict quality standards. Only the best quality materials are used.

Our assembly, logistic and R&D centre has been certified in accordance to ISO 9001-2008 ensuring that all our products meet the highest standards of quality and each item is carefully inspected before shipment to ensure customer satisfaction.

Our testing facilities include the latest state of-the-art equipments. Fans mounted with Fume Jet are rated and tested in accordance to ISO 5801 and AMCA 210, 260 and 300 standards. In many cases, factory acceptance tests (FAT) are arranged prior to delivery to ensure that all specifications and standards are met.

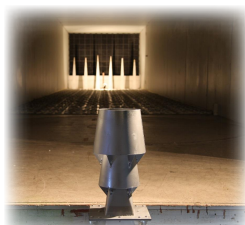

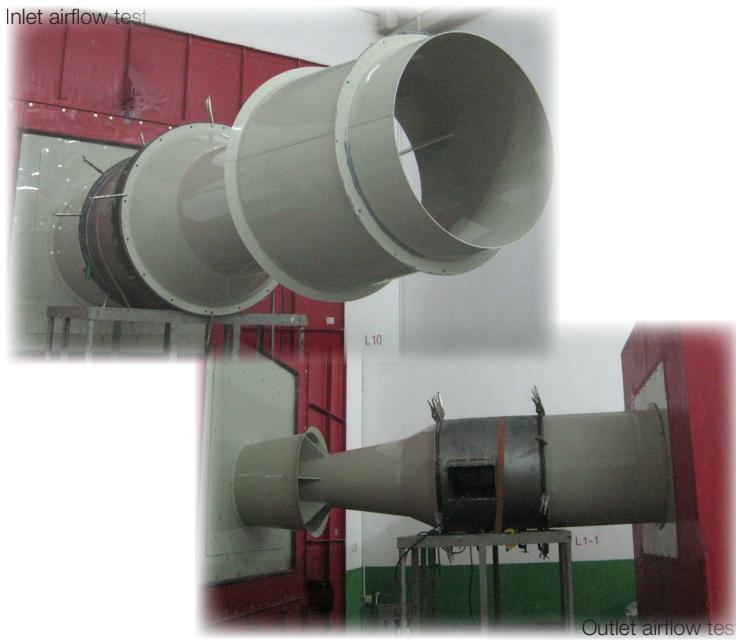

AMCA 260 Air Test Procedure

The following illustrations describe the procedure for determining the total laboratory exhaust fan discharge flow. The total discharge flow is the sum of inlet airflow and entrained airflow. The inlet air flow is determined first by using AMCA 210 Figure 15. Next, the key requirement to AMCA 260 is the variable resistance box. This box allows the measurement of total discharge flow ($P_s = 0$ Pa) to simulate discharging the fan to atmosphere) at all points along its fan curve. Without the variable resistance box, the entrained airflow can only be measured at the free air point of its fan curve. The entrained airflow obtained can be used to calculate an effective plume height. Therefore, AMCA 260 certification is necessary to ensure the laboratory exhaust fan specified is providing the plume rise and entrainment submitted.

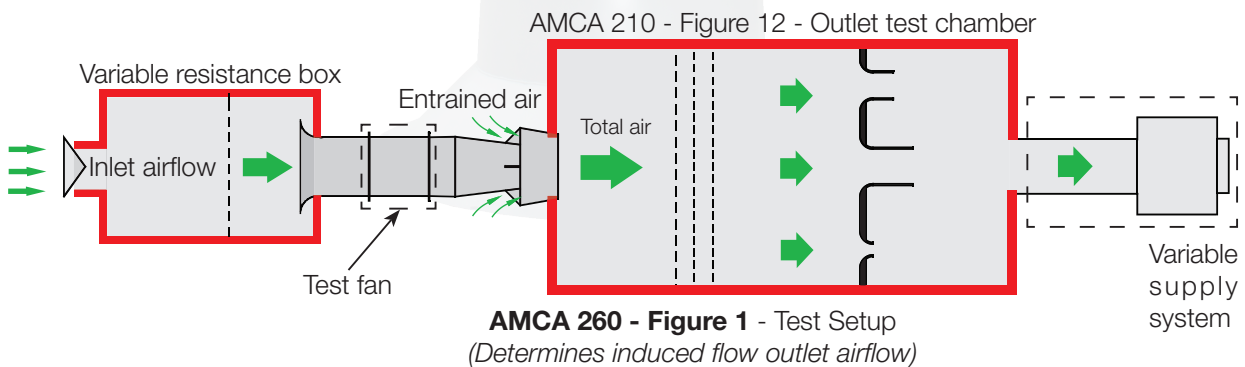
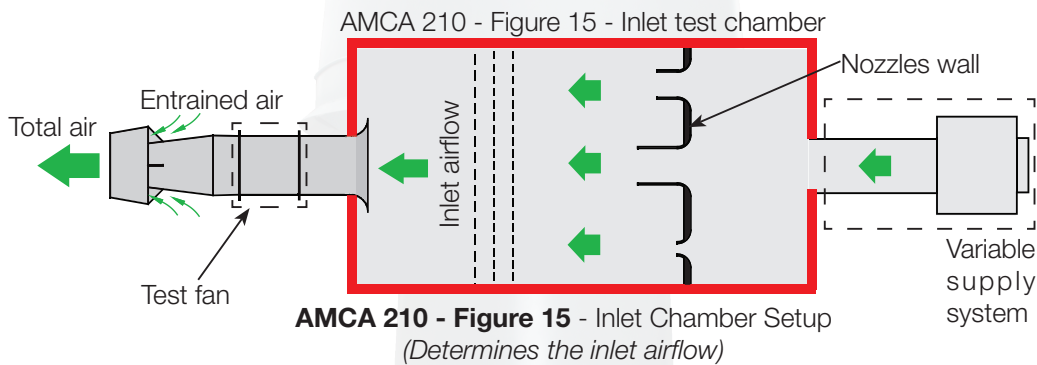

Performance Curves

The performance curves have been established using the inlet test method in the test chamber according to AMCA 210 installation type C (duct inlet, free outlet).

The curves indicate as a function of the volume flow:

- ▶ fan inlet airflow: the static pressure increase p_s for constant speed (heavy black lines)
- ▶ windband outlet airflow: the static pressure increase p_s for constant speed (heavy green lines)
- ▶ constant lines of shaft power P_w (red Lines)

All values relate to an air density: $\rho = 1.2 \text{ kg/m}^3$ at 20°C

The nozzle outlet velocity c_1 stated in the diagrams refer to the airflow of fan inlet and the outlet diameter of nozzle;

The windband outlet velocity c_2 stated in the diagrams refer to the airflow of windband outlet and the outlet diameter of windband;

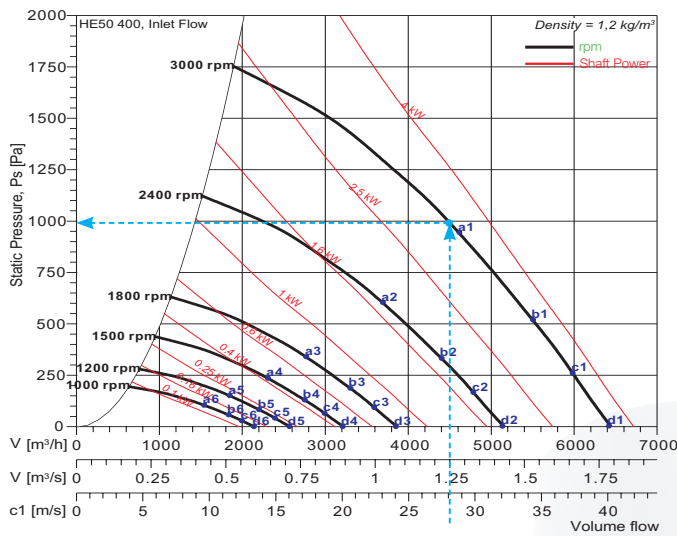

Figure 4, PF-WMX-HE50 400 Inlet airflow curve

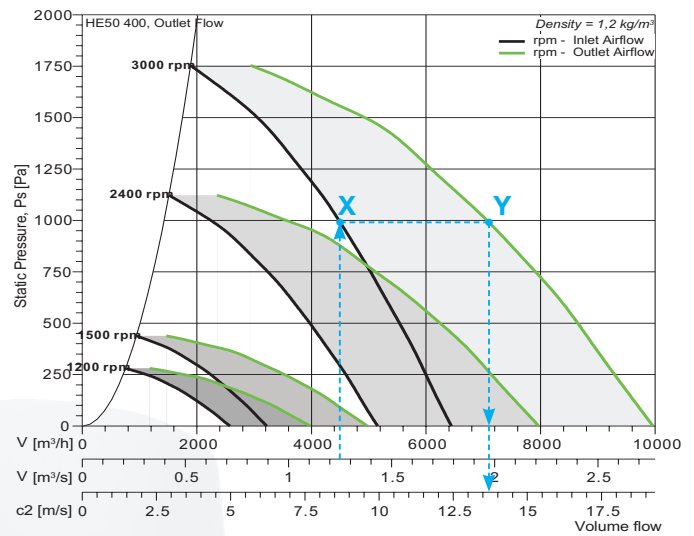

Figure 5, PF-WMX-HE50 400 Outlet airflow curve

Selection Example

1) Inlet flow curve

Required duty point:

- Volume air flow: 4,500 m³/h
- Static pressure: 992 Pa

Using the fan curve:

Having chosen a fan with adequate performance range for the required duty point, see the figure 4, plot volume flow and pressure. At the point of intersection, the following data can be read:

- Fan Speed: 3,000 rpm
- Shaft power: 3.36 kW
- Nozzle outlet velocity c1: 28.1 m/s
- Sound power level: ≈ a1 = 89 dB(A)

Sound Levels

In order to make possible an assessment of sound projection adequate to the human ear the A-assessed description of sound levels has been chosen. The ascertaining of the sound power level follows the reverberant room method according to AMCA 300. The sound power levels shown on each performance curve, outlet LwoA, refer to the overall sound power “A-Weighted” levels. The computed sound power levels were converted into A-Weighted levels using adjustments to the octave band spectrum as follows:

Centre Frequency Hz	63	125	250	500	1000	2000	4000	8000
A-Weighted Adjustment dB(A)	-26.2	-16.1	-8.6	-3.2	0	+1.2	+1.0	-1.1

The overall sound pressure levels, LpoA, can be calculated from the overall sound power levels as follows:

1) Free Field Conditions: $L_{poA} = L_{woA} - (20 \log_{10} d) - 11$

2) Room Conditions: $L_{poA} = L_{woA} - (20 \log_{10} d) - 7$

Where: d = distance from fan in meters

2) Outlet flow curve

Each fan has two performance curves associated with each rpm: the black curve is the fan inlet airflow curve and the green curve directly to the right is the windband outlet airflow curve. These curves have been connected with shading in grey color.

- Determining windband outlet volume, see the figure 5;
 - a. Find the duty point. Draw a horizontal line to the right from "X" to the green curve "Y".
 - b. The windband outlet volume is determined by "Y", so the windband outlet volume is 7,095 m³/h.
- Windband outlet average velocity c2 can be read by using the windband outlet volume: 13.7 m/s
- Entrainment ratio: Windband outlet volume / Fan inlet volume = 7,095 (m³/h) / 4,500 (m³/h) = 158%

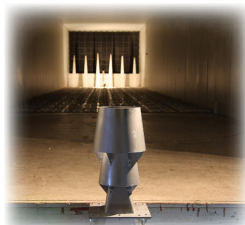

Laboratory Exhaust System

- › **Bypass Air (Q_B)**
Ambient air that is drawn through the bypass air plenum and mixed with the lab exhaust to increase dilution and plume rise. Bypass air is primarily used in variable volume applications to maintain a constant discharge volume but can also be used to increase overall exhaust volume and dilution.
- › **Dilution Ratio (D.R.)**
The ratio of the total fan outlet volume to the lab exhaust volume. (Total Volume / Lab Exhaust Air Volume). Value includes any additional bypass air in the calculation.
- › **Entrainment Air (Q_E)**
Air that is entrained (induced flow) through the windband and fan housing, mixed with the laboratory exhaust to increase the dilution ratio and plume rise.
- › **Entrainment Ratio (E.R.)**
The ratio of the total fan outlet volume to the fan inlet volume. (Total Volume / Fan Inlet Volume).
- › **Total Airflow (Q_T)**
The total airflow exiting the windband including fume exhaust, bypass air, and entrainment air. (See diagram to right).

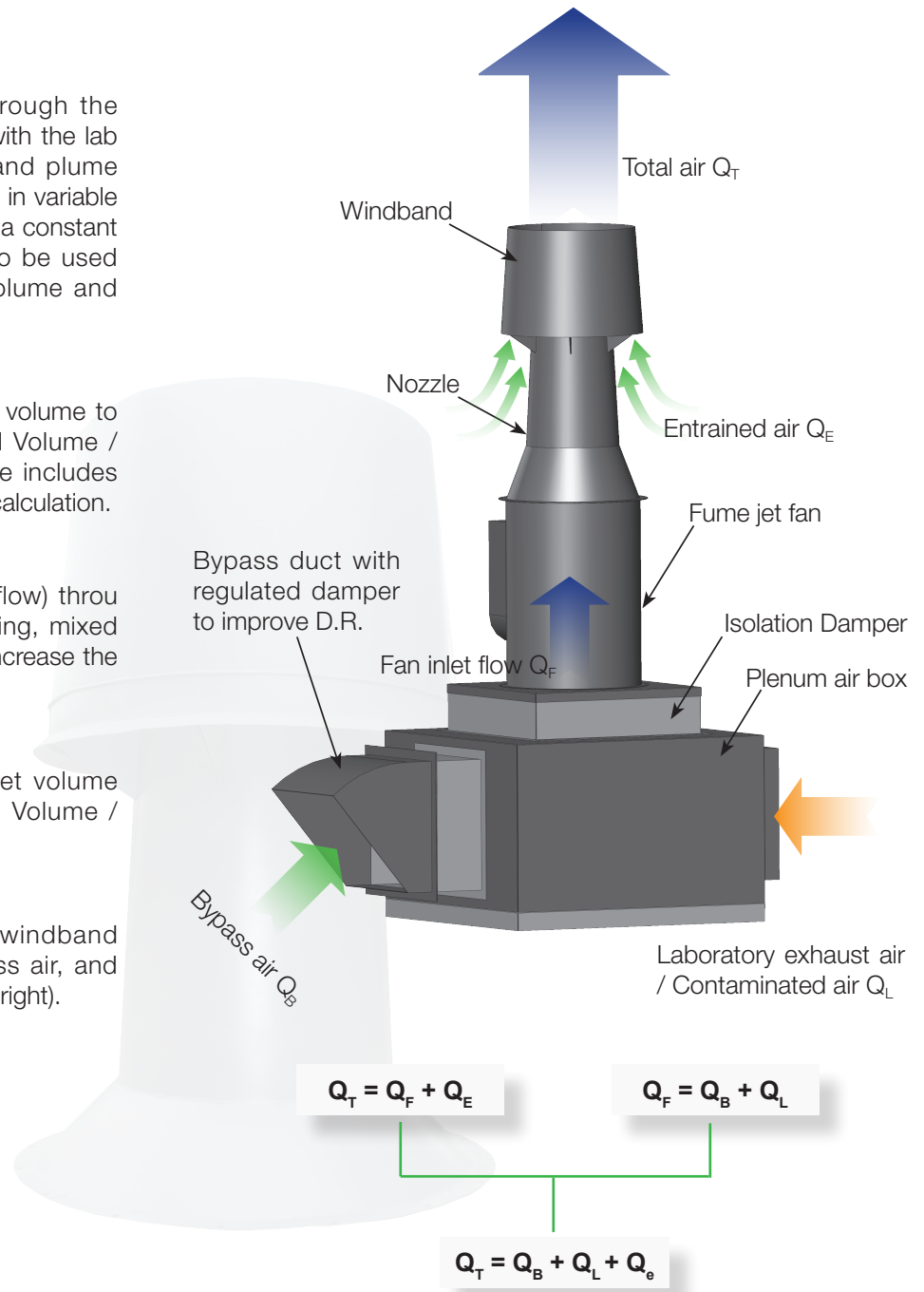

Dilution Ratio:
 $D.R = Q_T / Q_L$

Entrainment Ratio:
 $E.R = Q_T / Q_F$

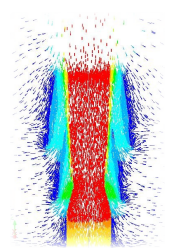

Effective Plume Height Calculation

When studying laboratory exhaust design issues, it is important to consider effective stack height. This is the physical height of the equipment plus the plume height. The following explains how this is calculated.

$$h_e = h_r + h_s^*$$

$$h_e = [3.0 \times V \times d / U] + h_s$$

where: h_s = fan height (dimensions section of this catalog); h_r = plume rise, (m); V = stack discharge velocity, (m/s); d = effective stack diameter, (m); U^{**} = cross wind velocity [m/s]

* From ASHRAE Laboratory Design Guide, Equation 9-2

** Plume rises shown on performance pages are calculated with a 10 mph (4.47 m/s) crosswind.

Pressure Loss and Effective Plume Height Selection

Example:

Flow volume at 4,500 m³/h with system static pressure 992 pa. Minimal height from floor is 8 meter. Max. fan rpm at 3000.

- 1) Refer to the Wolter's CHEMCO fan curve, select a fan to meet the above specification.
- 2) Base on fan curve PF-WMX-HE50 400 can perform the job.
- 3) Air flowing through Fume Jet will encounters resistance to flow due to friction losses and turbulence losses. Refer to the graph "Pressure Loss due to Jet Action (HE50 / HDE90 Type)" on page 24 for the actual fan pressure. So the pressure loss caused by nozzle is 436 pa, actual fan static pressure = 992 + 436 = 1428 pa
- 4) Fan data: PF-WMX-HE50 400 with RPM at 3,000, 3.36kW shaft power;
- 5) Refer to graph "Effective Plume Rise h_r - HE50 Series, Fan Sizes 315 to 630" on page 26. From 4,500 m³/h intersect size 400 curve result h_r = 5.480 m.
- 6) Refer to Wolter's CHEMCO Fume Jet dimensions chart for PF-WMX-HE50 400 total height from floor level: h_s = 3.166 m

Total effective plume height h_e = 5.480 + 3.025 = 8.505 meters.

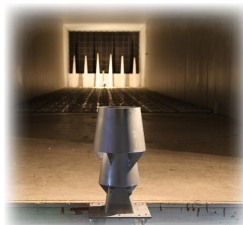
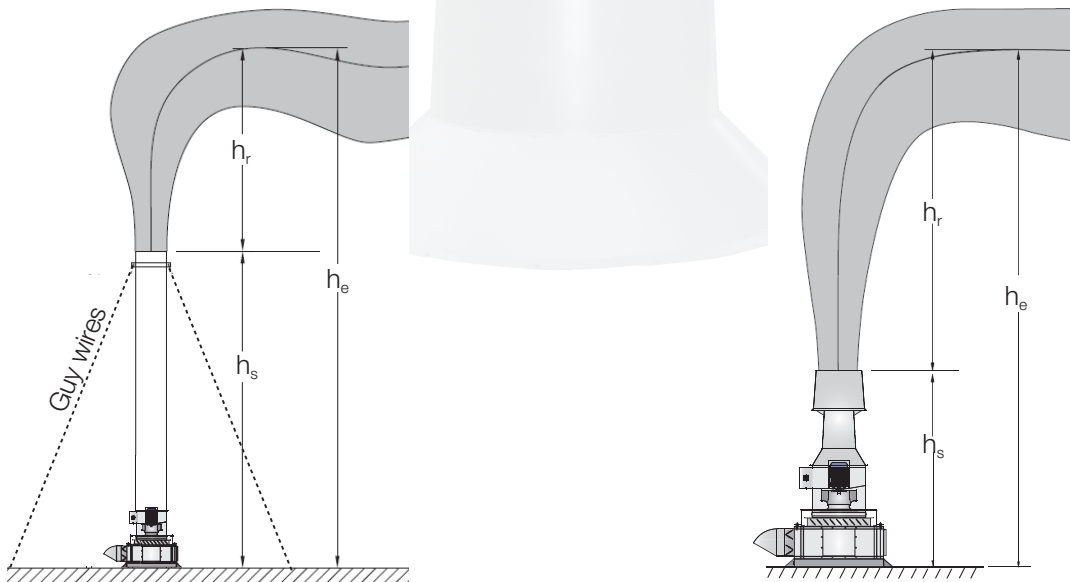

Performance Curve

PF-WMX-SE30 315 PF-WMX-HE50 315 PF-WMX-HDE90 315

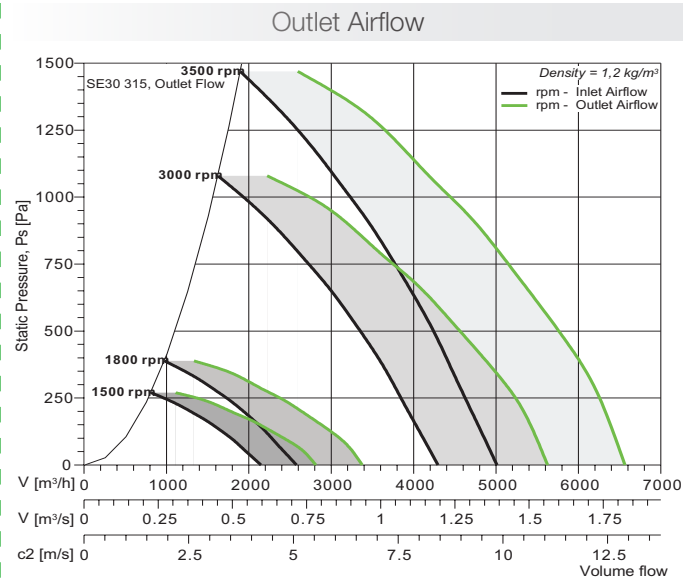
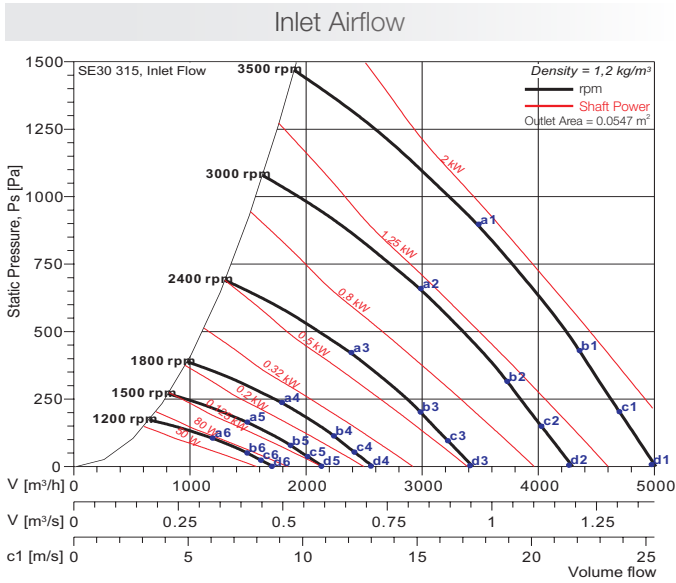

SE 30

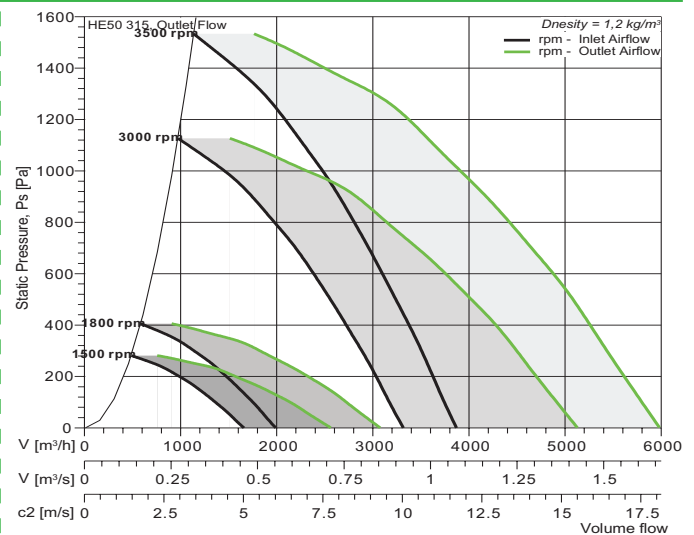
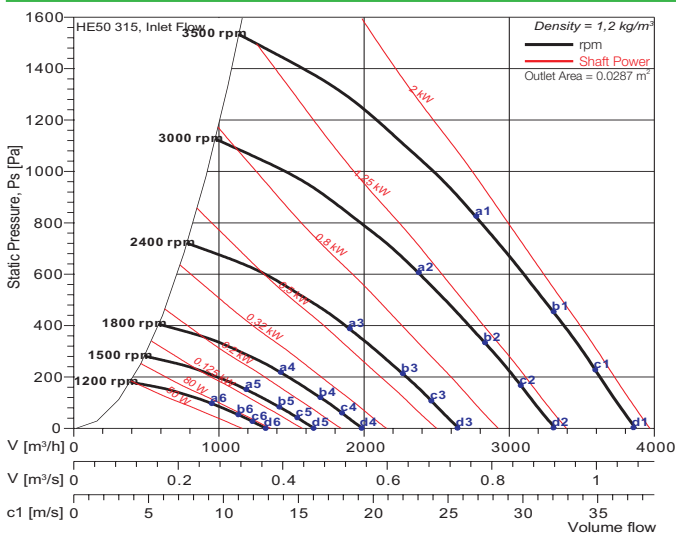

HE 50

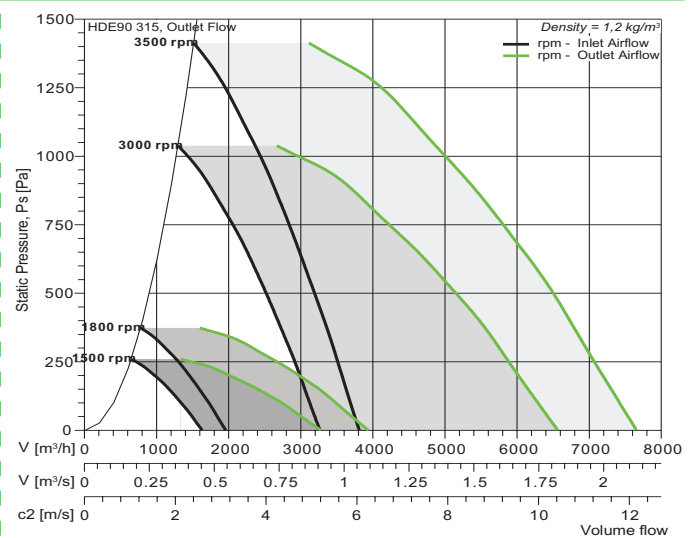
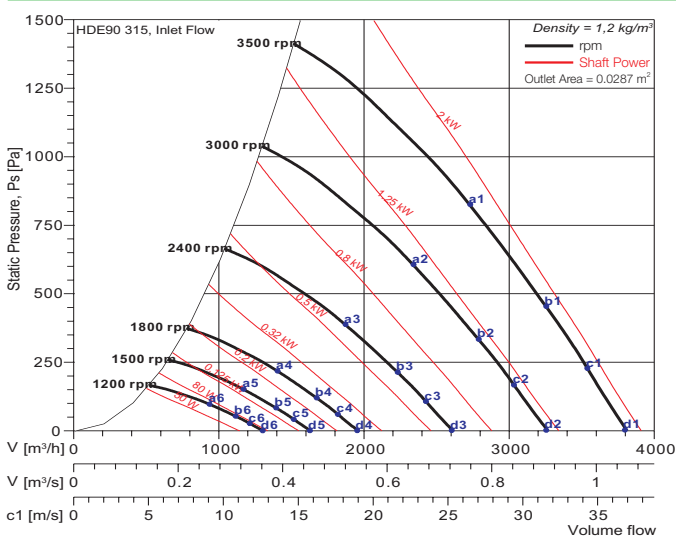

HDE 90 (non-AMCA)

The A-weighted Sound Power Levels

Lwo(A)	a1	b1	c1	d1	a2	b2	c2	d2	a3	b3	c3	d3	a4	b4	c4	d4	a5	b5	c5	d5	a6	b6	c6	d6
SE 30	87	90	91	92	82	85	85	86	76	79	80	81	71	74	75	76	64	67	68	69	58	61	62	63
HE 50	86	88	88	88	80	82	83	83	75	77	77	77	70	72	72	72	62	64	64	65	56	59	59	59
HDE 90	85	87	87	87	79	81	82	82	74	76	76	76	69	71	71	71	61	63	64	65	58	58	58	58

Fan test laboratory AMCA 210, 260 & 300. Performance certified for installation type C - Ducted inlet, Free outlet. Power rating (kW) does not include transmission losses. Performance ratings do not include the effects of cross winds. Performance ratings do not include the effects of appurtenances (accessories).

NB: PF-WMX-HDE 90 315 is not licensed to bear the AMCA certified rating seal. The A-weighted sound ratings shown have been calculated per AMCA International Standard 301. Values shown are for outlet LwoA sound power levels for installation Type C: ducted inlet, free outlet.

Performance Curve

PF-WMX-SE30 355 PF-WMX-HE50 355 PF-WMX-HDE90 355



SE 30

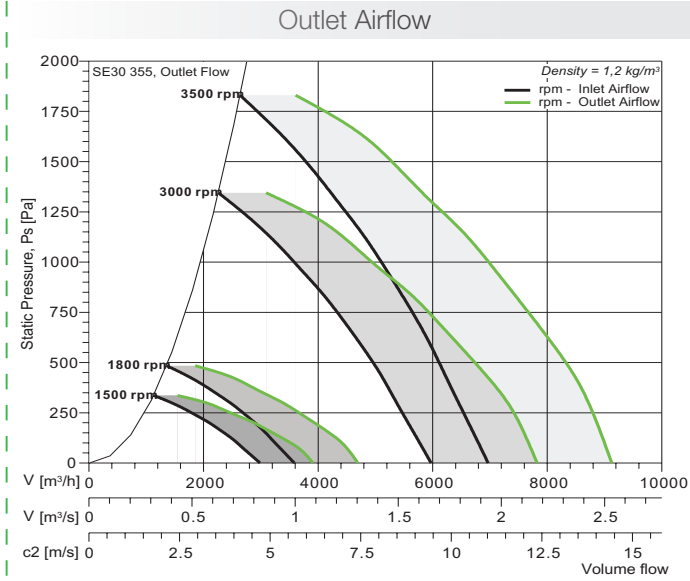
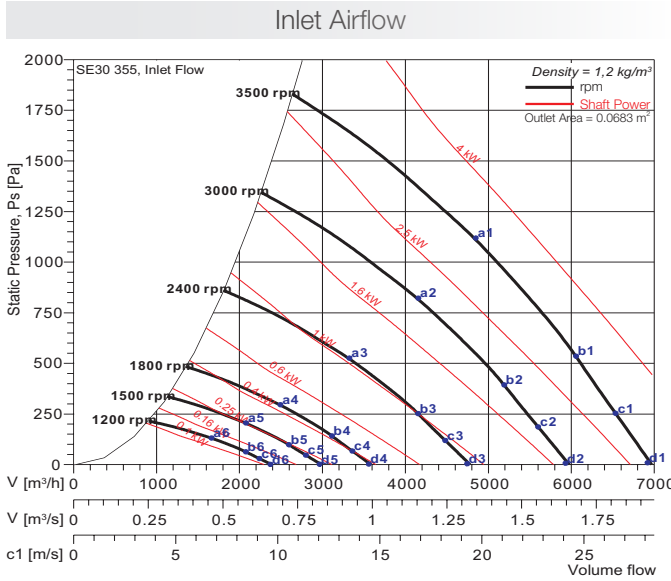

HE 50

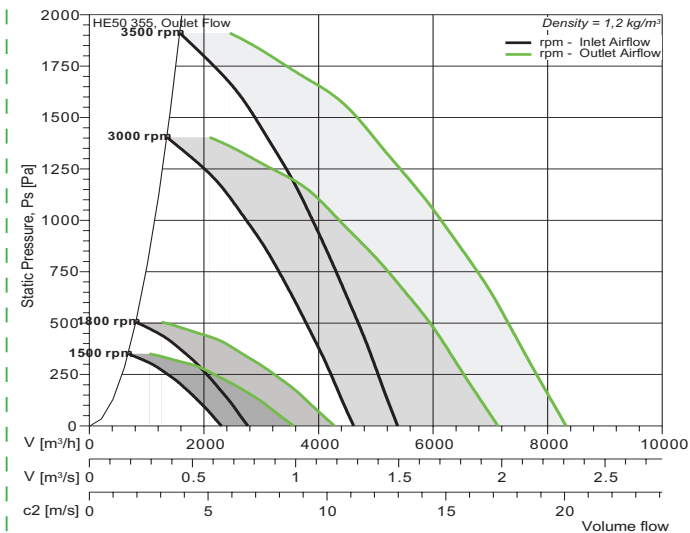
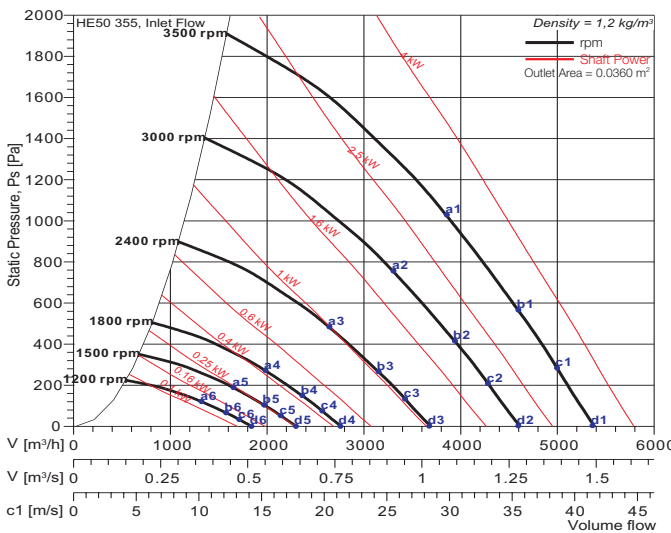

HDE 90 (non-AMCA)

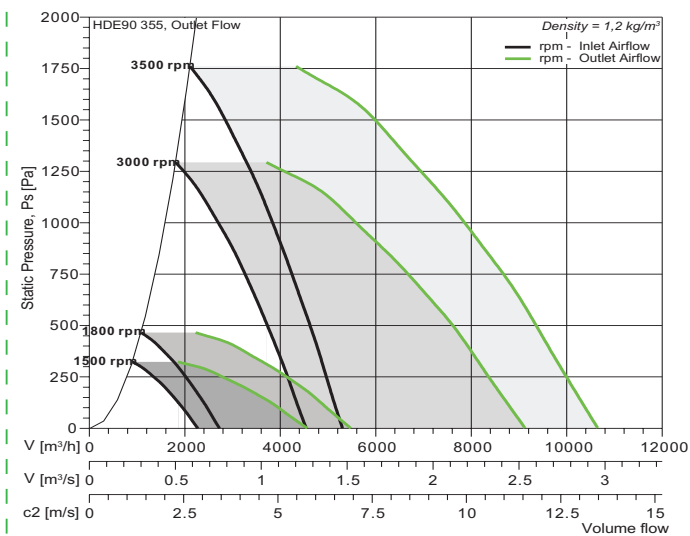
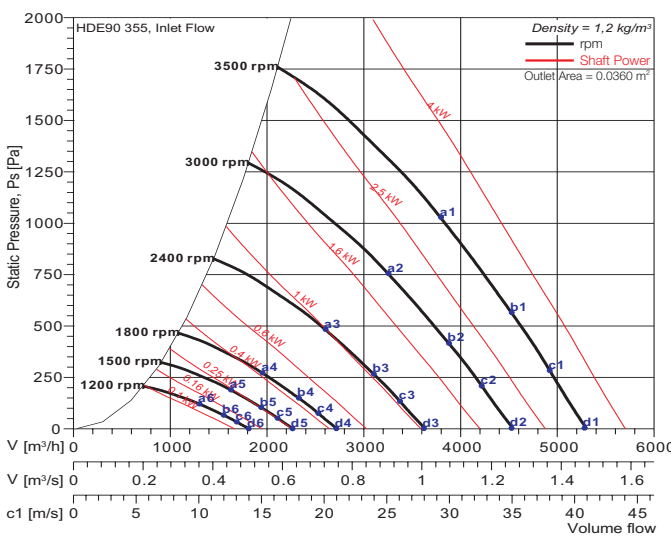

The A-weighted Sound Power Levels

Lwo(A)	a1	b1	c1	d1	a2	b2	c2	d2	a3	b3	c3	d3	a4	b4	c4	d4	a5	b5	c5	d5	a6	b6	c6	d6
SE 30	91	94	94	95	87	90	90	91	81	84	85	86	74	77	78	79	69	72	73	74	63	66	67	68
HE 50	89	91	92	92	85	87	88	88	80	82	82	82	73	75	75	75	67	69	70	70	62	64	64	64
HDE 90	88	90	91	91	84	86	87	87	79	81	81	81	72	74	74	74	66	68	69	69	61	63	63	63

Fan test laboratory AMCA 210, 260 & 300. Performance certified for installation type C - Ducted inlet, Free outlet. Power rating (kW) does not include transmission losses. Performance ratings do not include the effects of cross winds. Performance ratings do not include the effects of aperturances (accessories).

NB: PF-WMX-HDE 90 355 is not licensed to bear the AMCA certified rating seal. The A-weighted sound ratings shown have been calculated per AMCA International Standard 301. Values shown are for outlet LwoA sound power levels for installation Type C: ducted inlet, free outlet.

Performance Curve

PF-WMX-SE30 400 PF-WMX-HE50 400 PF-WMX-HDE90 400

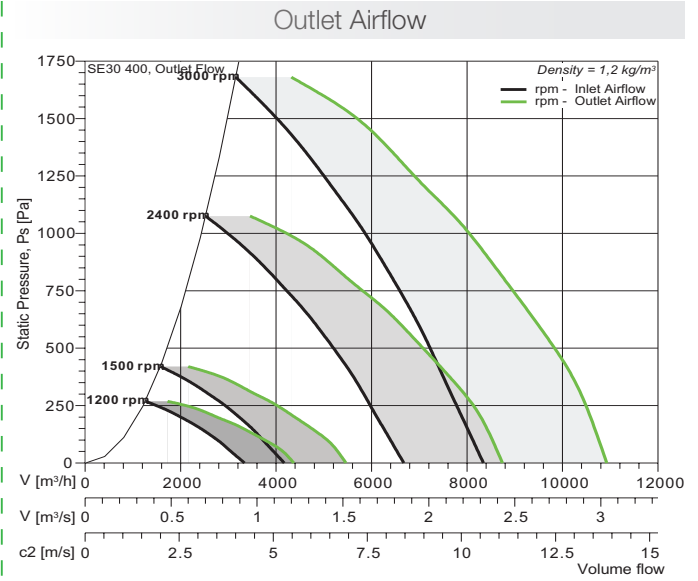
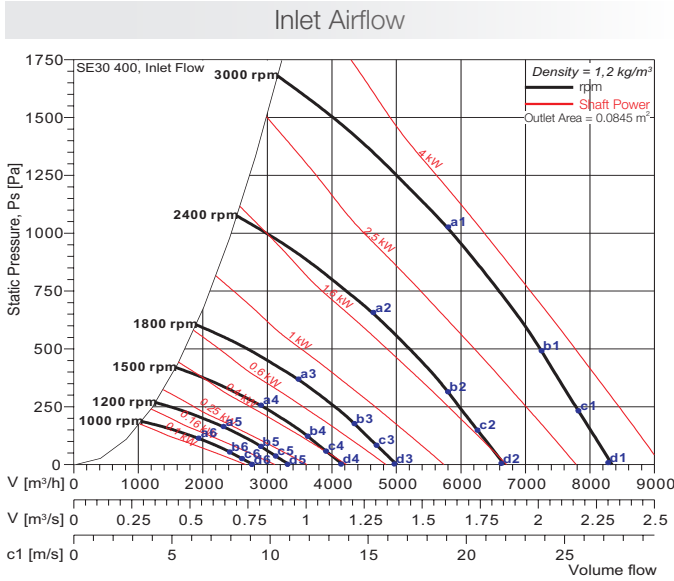

SE 30

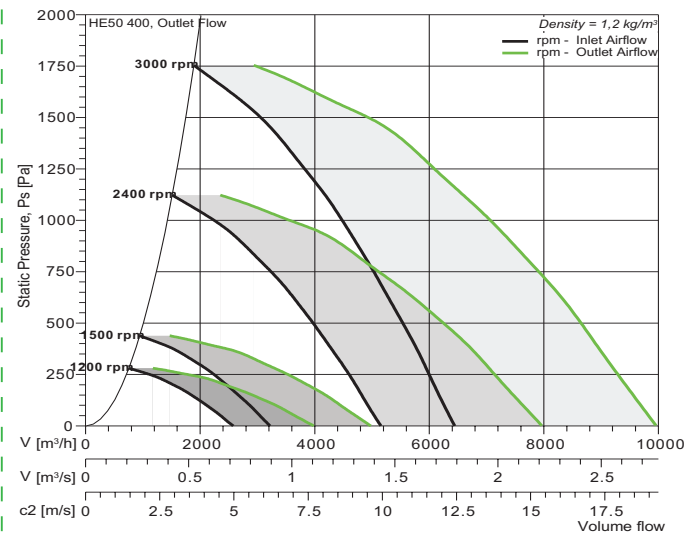
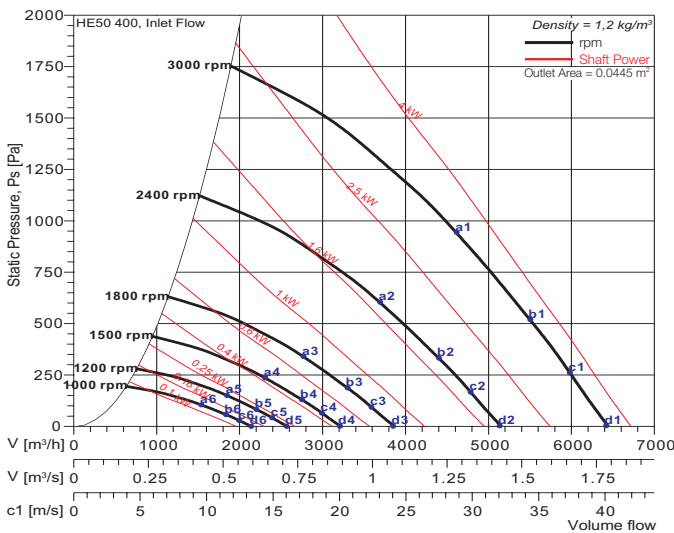

HE 50

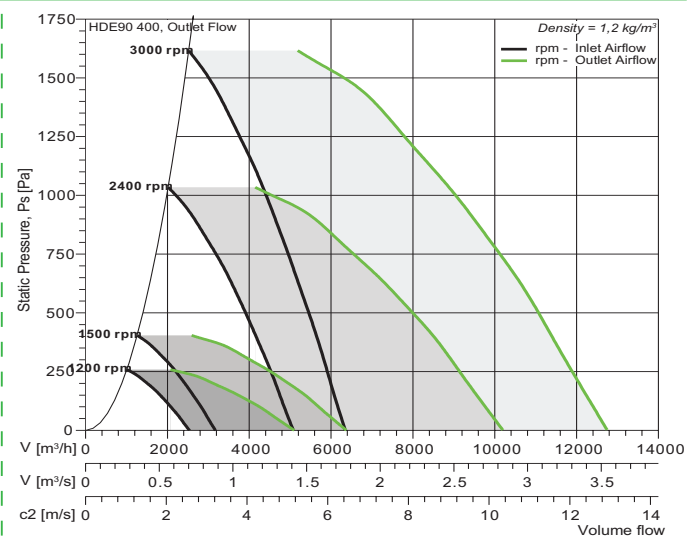
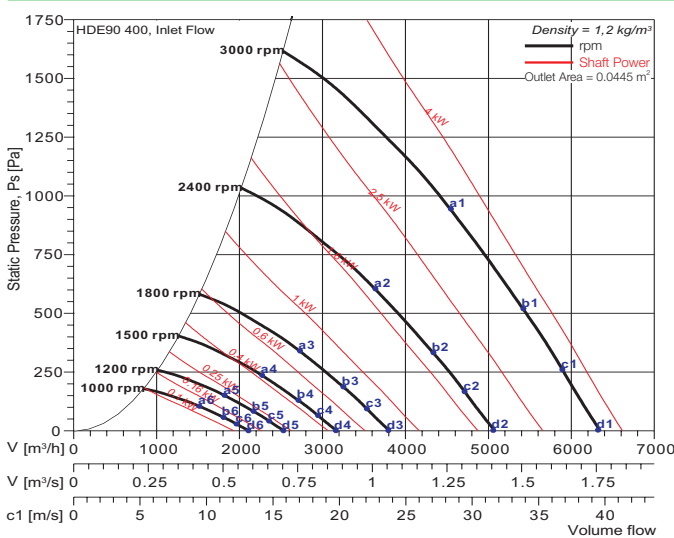

HDE 90 (non-AMCA)

The A-weighted Sound Power Levels

Lwo(A)	a1	b1	c1	d1	a2	b2	c2	d2	a3	b3	c3	d3	a4	b4	c4	d4	a5	b5	c5	d5	a6	b6	c6	d6
SE 30	90	93	94	95	85	88	88	89	78	81	81	82	73	76	76	78	67	70	71	72	62	65	66	67
HE 50	89	91	91	91	83	85	86	86	77	79	79	79	71	73	73	73	65	67	67	67	60	62	63	63
HDE 90	88	90	90	90	82	84	85	85	76	78	78	78	70	72	72	72	64	66	66	66	59	61	62	62

Fan test laboratory AMCA 210, 260 & 300. Performance certified for installation type C - Ducted inlet, Free outlet. Power rating (kW) does not include transmission losses. Performance ratings do not include the effects of cross winds. Performance ratings do not include the effects of appurtenances (accessories).

NB: PF-WMX-HDE 90 400 is not licensed to bear the AMCA certified rating seal. The A-weighted sound ratings shown have been calculated per AMCA International Standard 301. Values shown are for outlet LwoA sound power levels for installation Type C: ducted inlet, free outlet.

Performance Curve

PF-WMX-SE30 450 PF-WMX-HE50 450 PF-WMX-HDE90 450



SE 30

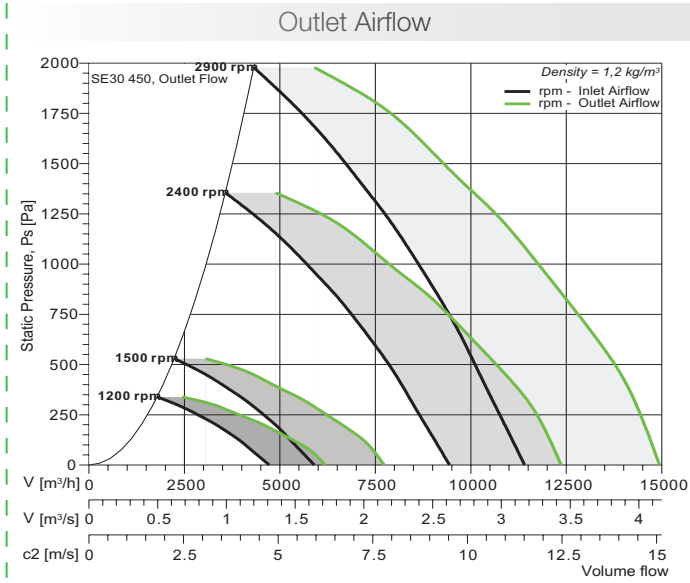
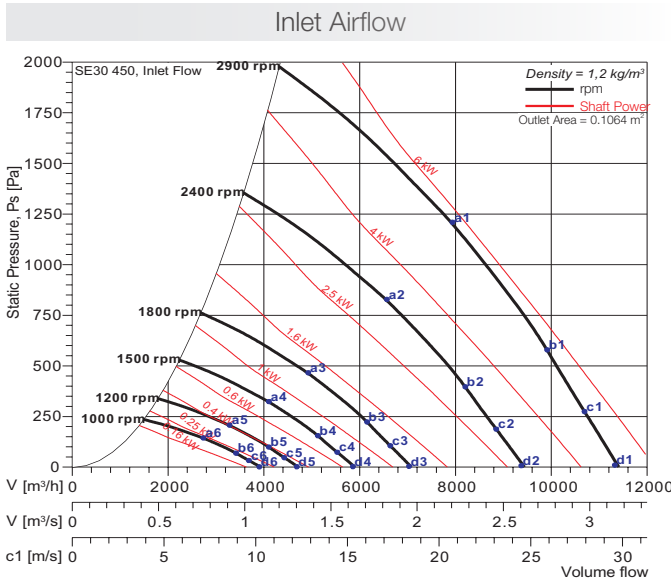

HE 50

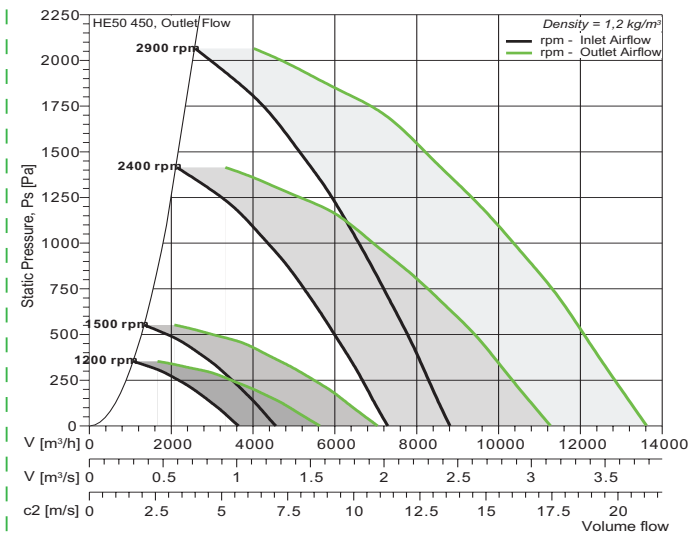
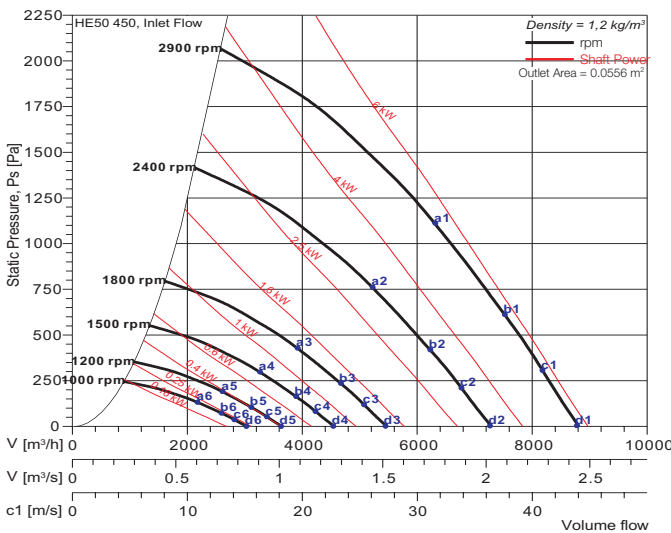

HDE 90 (non-AMCA)

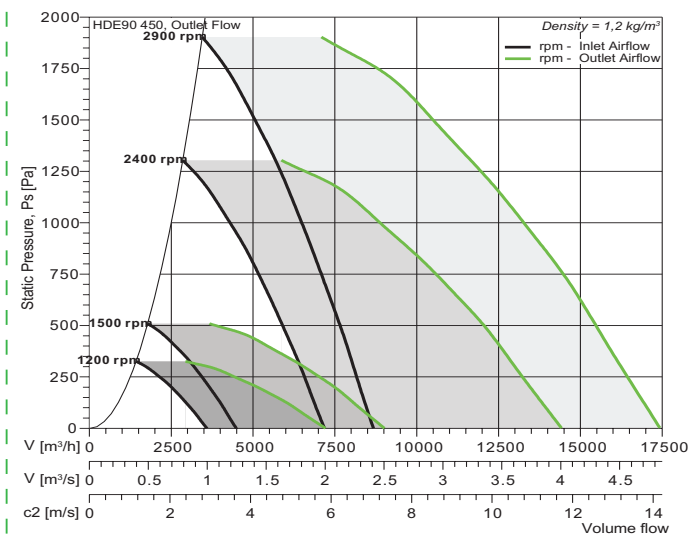
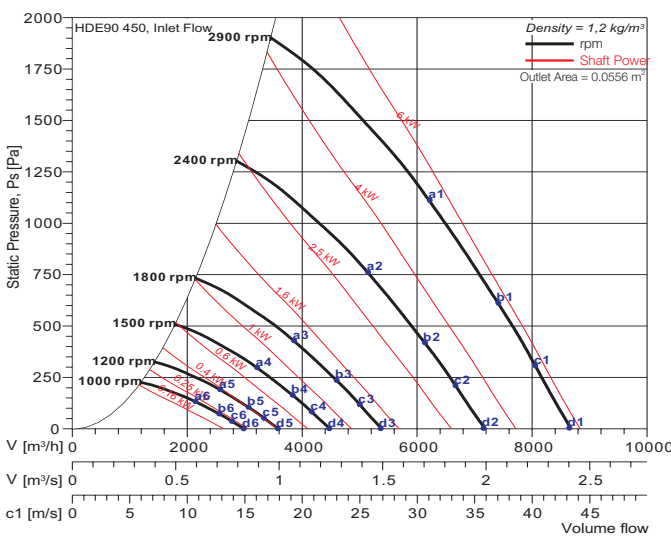

The A-weighted Sound Power Levels

Lwo(A)	a1	b1	c1	d1	a2	b2	c2	d2	a3	b3	c3	d3	a4	b4	c4	d4	a5	b5	c5	d5	a6	b6	c6	d6
SE 30	93	96	97	97	88	91	92	93	81	84	85	86	76	79	80	81	70	73	74	75	66	69	70	71
HE 50	91	94	94	94	87	89	89	89	80	82	82	82	74	76	76	77	68	71	71	71	64	66	66	66
HDE 90	90	93	93	93	86	88	88	88	79	81	81	81	73	75	75	76	67	70	70	70	63	65	65	65

Fan test laboratory AMCA 210, 260 & 300. Performance certified for installation type C - Ducted inlet, Free outlet. Power rating (kW) does not include transmission losses. Performance ratings do not include the effects of cross winds. Performance ratings do not include the effects of apertures/accessories.

NB: PF-WMX-HDE 90 450 is not licensed to bear the AMCA certified rating seal. The A-weighted sound ratings shown have been calculated per AMCA International Standard 301. Values shown are for outlet LwoA sound power levels for installation Type C: ducted inlet, free outlet.

Performance Curve

PF-WMX-SE30 500 PF-WMX-HE50 500 PF-WMX-HDE90 500

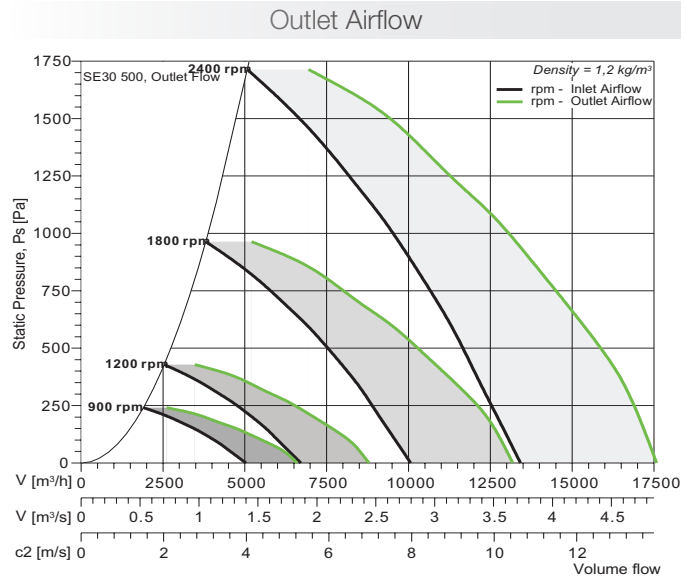
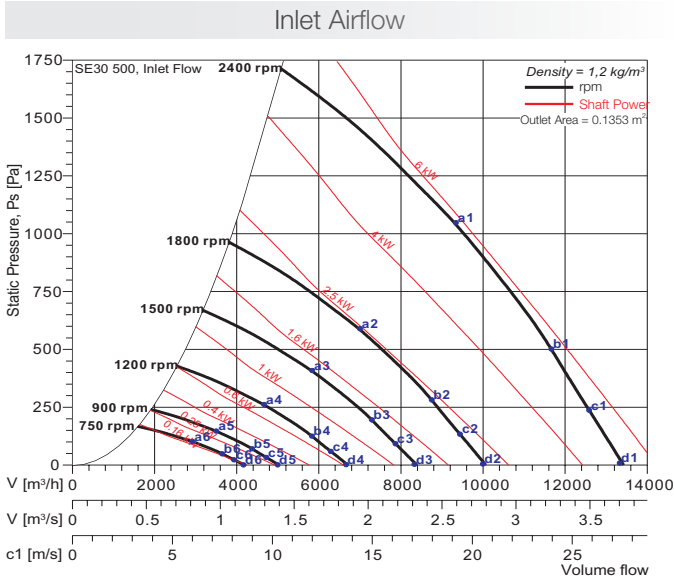

SE 30

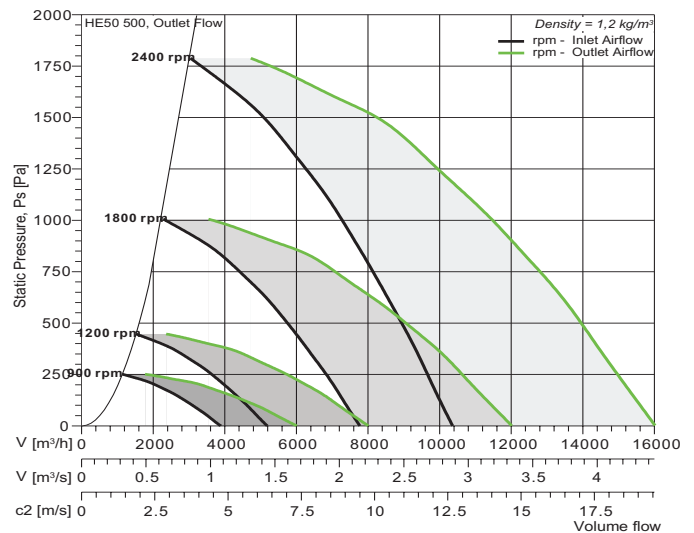
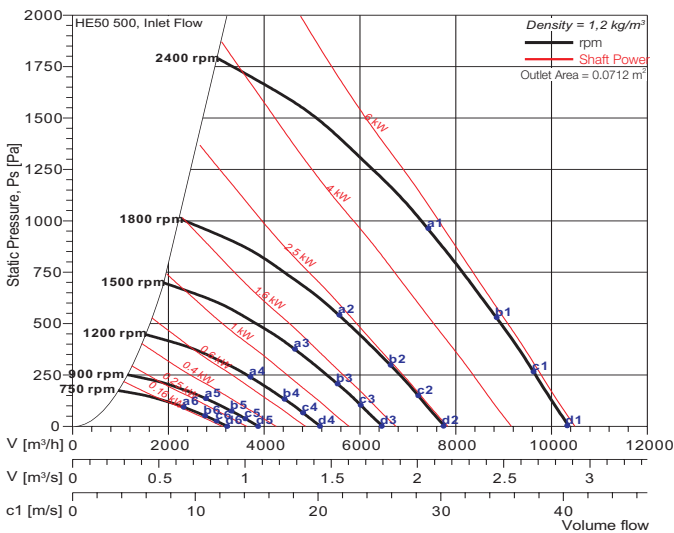

HE 50

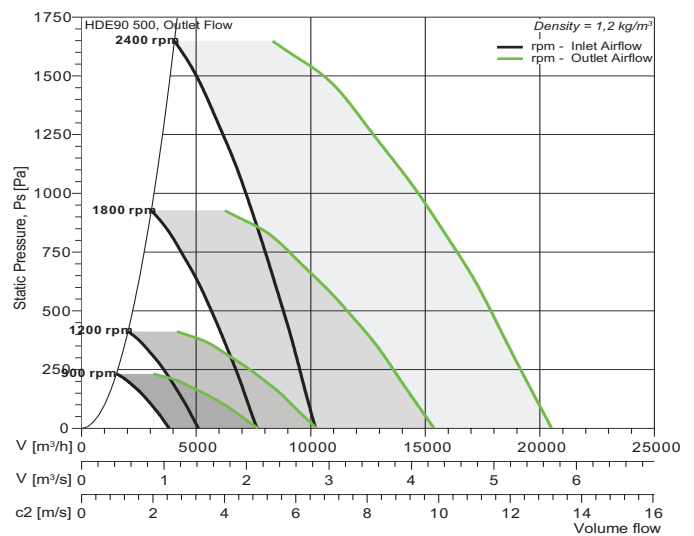
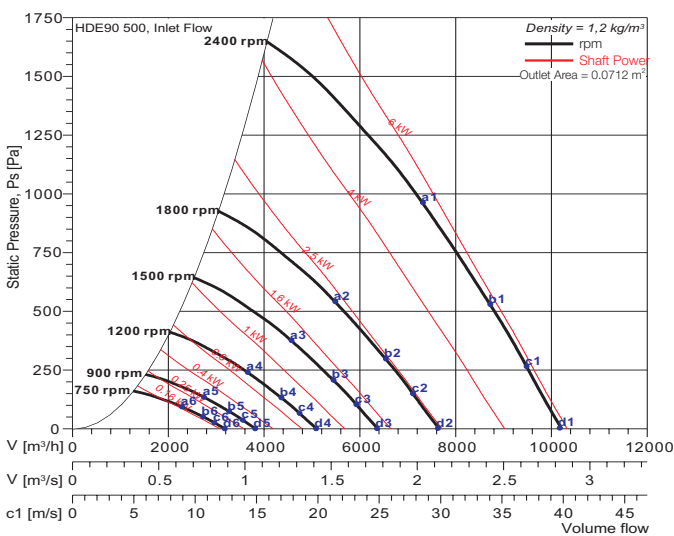

HDE 90 (non-AMCA)

The A-weighted Sound Power Levels

Lwo(A)	a1	b1	c1	d1	a2	b2	c2	d2	a3	b3	c3	d3	a4	b4	c4	d4	a5	b5	c5	d5	a6	b6	c6	d6
SE 30	92	95	95	96	85	88	88	89	80	83	83	85	74	77	78	79	66	70	70	72	61	65	65	67
HE 50	90	93	93	93	84	86	86	86	79	82	82	81	72	74	74	74	65	67	67	67	60	62	62	62
HDE 90	89	92	92	92	83	85	85	85	77	79	79	79	71	73	73	73	64	66	66	66	58	60	61	61

Fan test laboratory AMCA 210, 260 & 300. Performance certified is for installation type C - Ducted inlet, Free outlet. Power rating (kW) does not include transmission losses. Performance ratings do not include the effects of cross winds. Performance ratings do not include the effects of appurtenances (accessories).

NB: PF-WMX-HDE 90 500 is not licensed to bear the AMCA certified rating seal. The A-weighted sound ratings shown have been calculated per AMCA International Standard 301. Values shown are for outlet LwoA sound power levels for installation Type C: ducted inlet, free outlet.

Performance Curve

PF-WMX-SE30 560
PF-WMX-HE50 560
PF-WMX-HDE90 560



SE 30

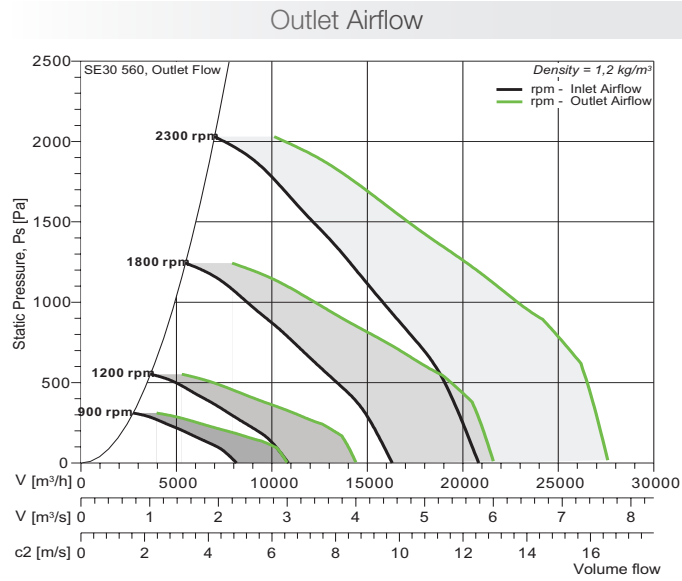
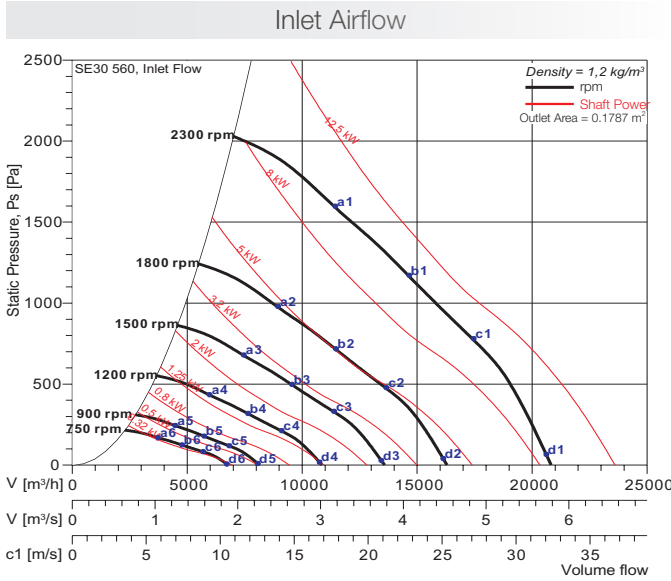

HE 50

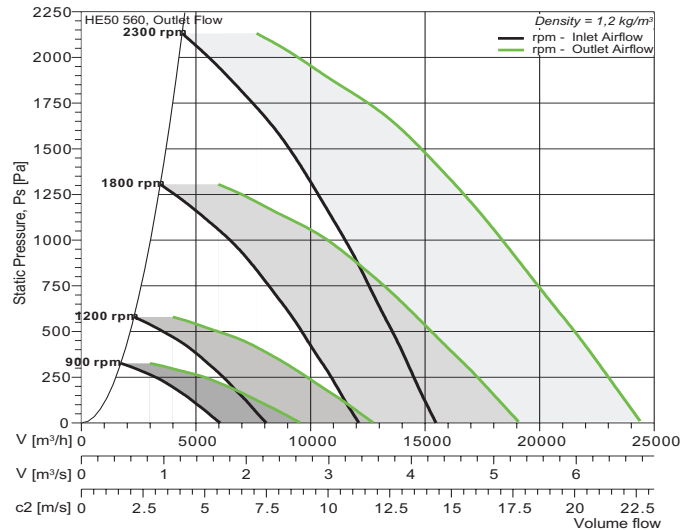
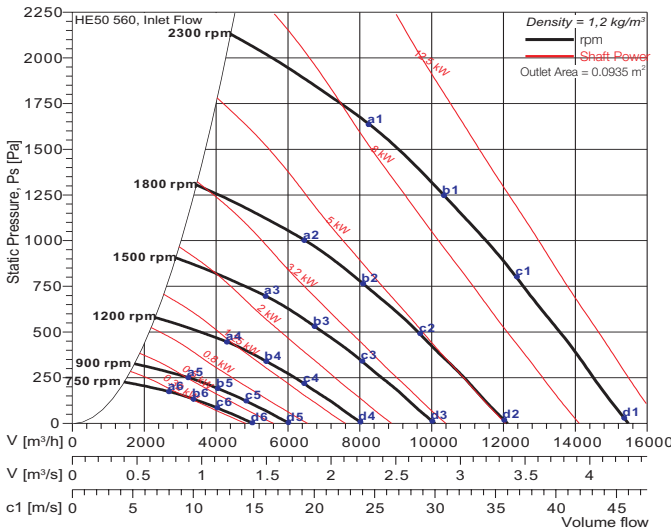

HDE 90 (non-AMCA)

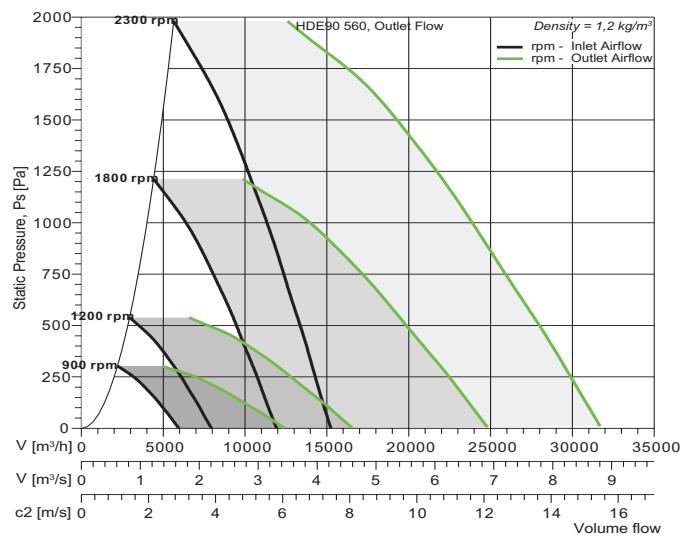
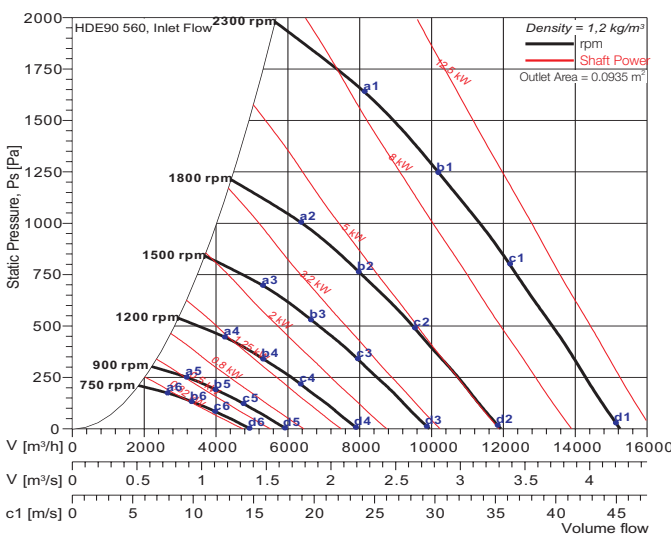

The A-weighted Sound Power Levels

Lwo(A)	a1	b1	c1	d1	a2	b2	c2	d2	a3	b3	c3	d3	a4	b4	c4	d4	a5	b5	c5	d5	a6	b6	c6	d6
SE 30	93	96	97	97	88	91	92	93	84	84	85	86	76	79	80	81	70	73	74	75	66	69	70	71
HE 50	92	92	92	94	85	85	86	88	80	81	81	83	74	75	76	77	67	67	68	69	62	63	63	65
HDE 90	91	91	91	93	84	84	85	87	79	80	80	82	73	74	75	76	66	66	67	68	61	62	62	64

Fan test laboratory AMCA 210, 260 & 300. Performance certified for installation type C - ducted inlet, Free outlet. Power rating (kW) does not include transmission losses. Performance ratings do not include the effects of cross winds. Performance ratings do not include the effects of apertures (accessories).

NB: PF-WMX-HDE 90 560 is not licensed to bear the AMCA certified rating seal. The A-weighted sound ratings shown have been calculated per AMCA International Standard 301. Values shown are for outlet LwoA sound power levels for installation Type C: ducted inlet, free outlet.

Performance Curve

PF-WMX-SE30 630
PF-WMX-HE50 630
PF-WMX-HDE90 630



Inlet Airflow

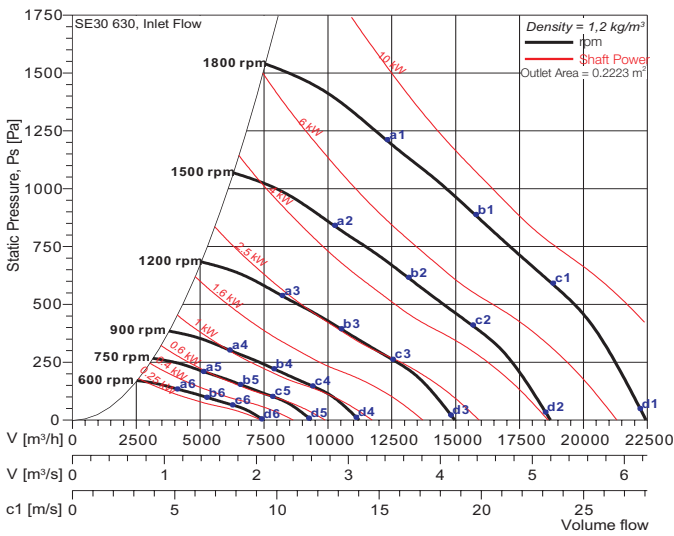

Outlet Airflow

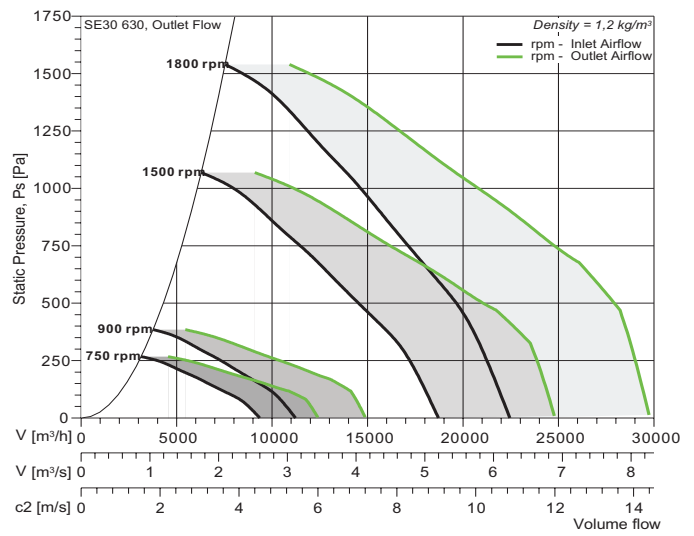

SE 30

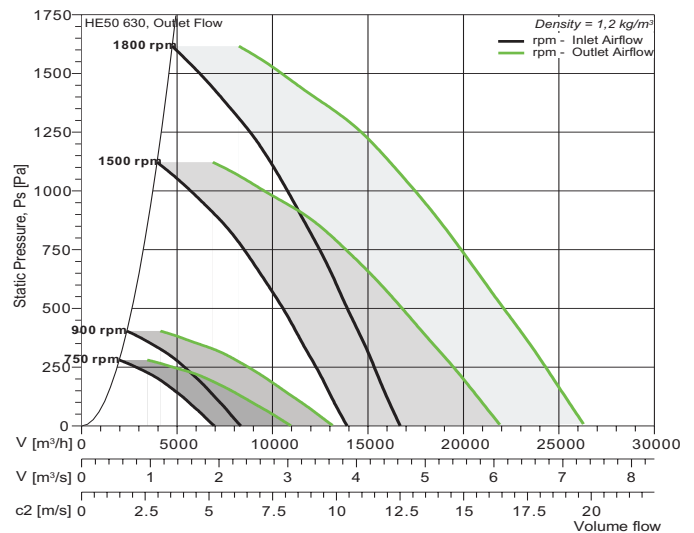
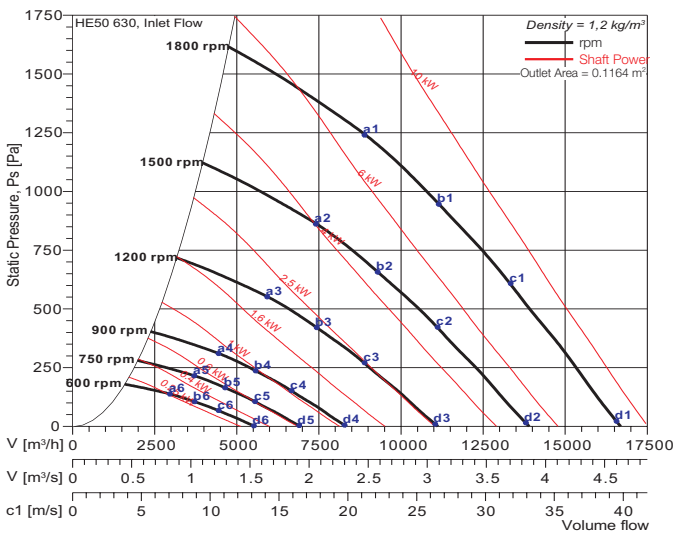

HE 50

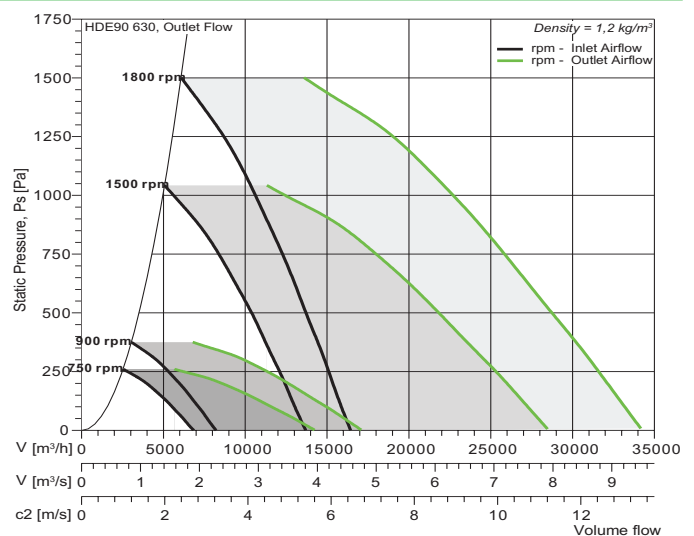
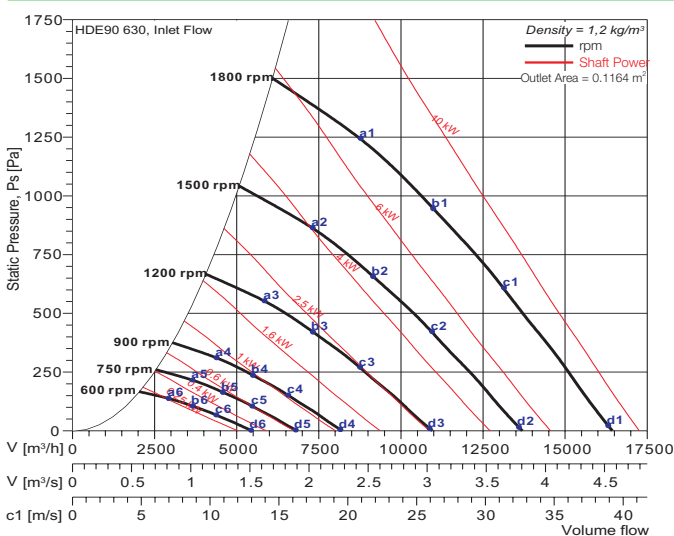

HDE 90 (non-AMCA)

The A-weighted Sound Power Levels

Lwo(A)	a1	b1	c1	d1	a2	b2	c2	d2	a3	b3	c3	d3	a4	b4	c4	d4	a5	b5	c5	d5	a6	b6	c6	d6
SE 30	90	91	93	95	86	87	88	90	80	81	82	85	73	74	75	77	68	69	70	73	62	63	64	67
HE 50	88	88	89	91	84	84	85	86	78	78	79	80	70	71	71	73	65	66	66	68	59	60	60	62
HDE 90	87	87	88	90	83	83	84	85	77	77	78	79	69	70	70	72	64	65	65	67	58	59	59	61

Fan test laboratory AMCA 210, 260 & 300. Performance certified for installation type C - Ducted inlet, Free outlet. Power rating (kW) does not include transmission losses. Performance ratings do not include the effects of cross winds. Performance ratings do not include the effects of appurtenances (accessories).

NB: PF-WMX-HDE 90 630 is not licensed to bear the AMCA certified rating seal. The A-weighted sound ratings shown have been calculated per AMCA International Standard 301. Values shown are for outlet LwoA sound power levels for installation Type C: ducted inlet, free outlet.

Performance Curve

PF-WMX-SE30 710 PF-WMX-HE50 710 PF-WMX-HDE90 710



SE 30

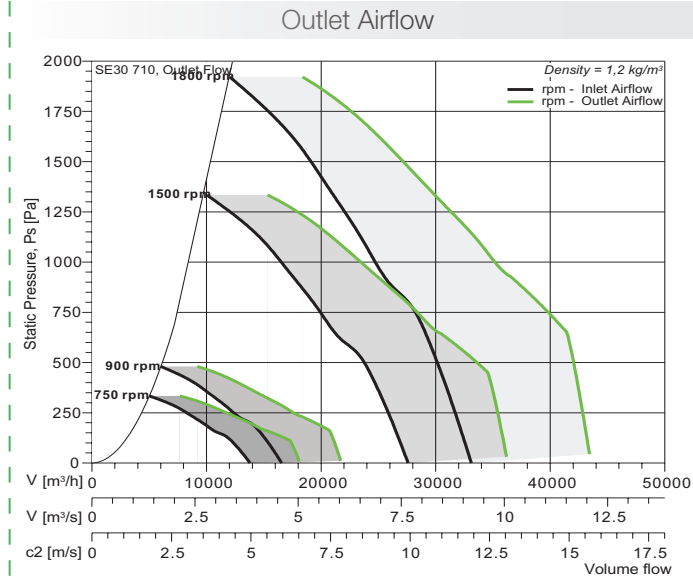
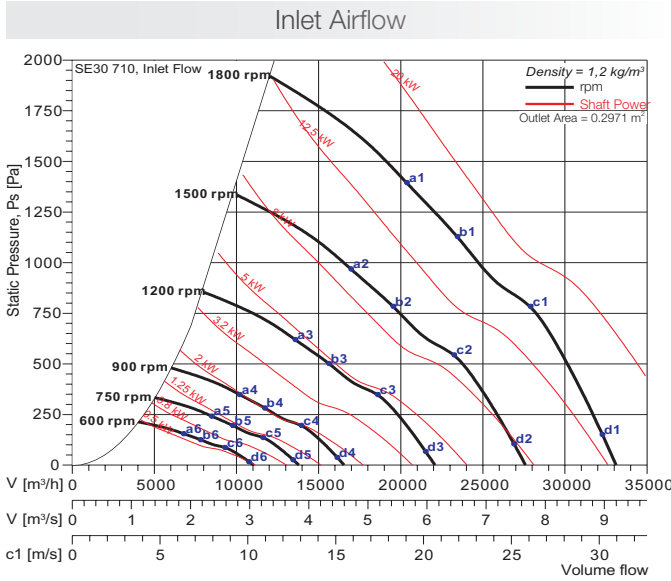

HE 50

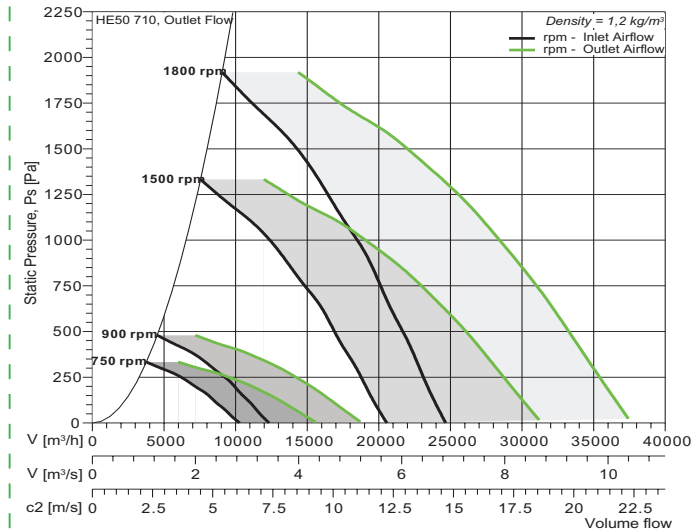
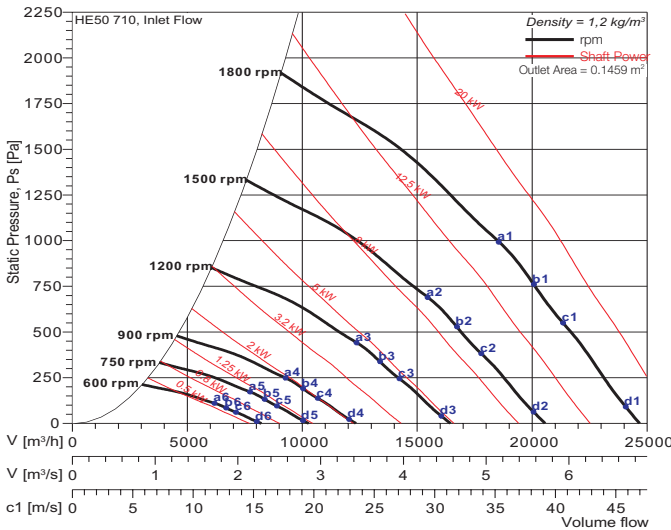

HDE 90 (non-AMCA)

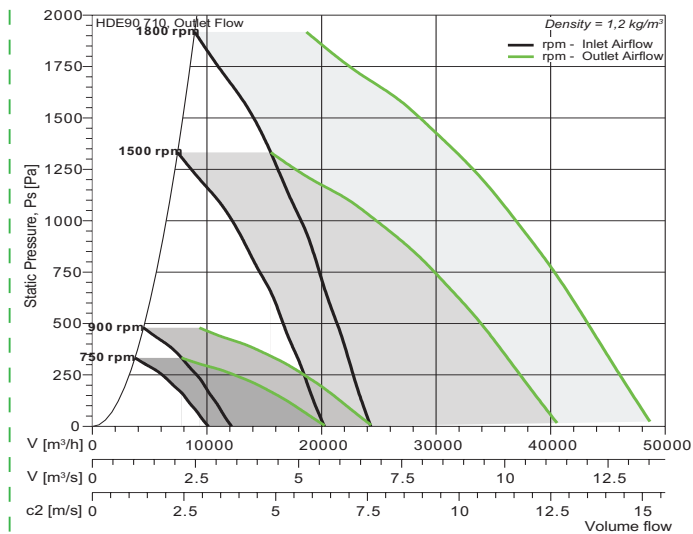
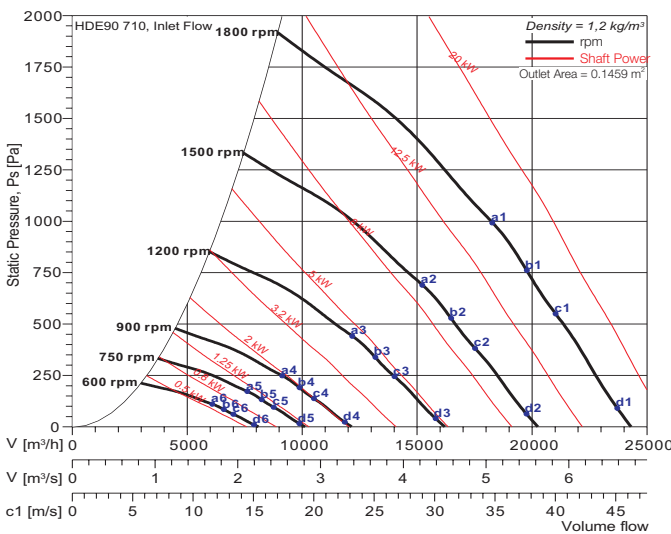

The A-weighted Sound Power Levels

Lwo(A)	a1	b1	c1	d1	a2	b2	c2	d2	a3	b3	c3	d3	a4	b4	c4	d4	a5	b5	c5	d5	a6	b6	c6	d6
SE 30	95	96	98	100	90	92	93	96	84	86	87	90	77	78	80	82	72	73	75	78	65	67	69	72
HE 50	93	93	94	95	88	88	89	90	82	82	83	84	74	75	75	77	69	70	70	72	63	64	64	65
HDE 90	92	92	93	94	87	87	88	89	81	81	82	83	73	74	74	76	68	69	69	70	62	63	63	64

Fan test laboratory AMCA 210, 260 & 300. Performance certified for installation type C - Ducted inlet, Free outlet. Power rating (kW) does not include transmission losses. Performance ratings do not include the effects of cross winds. Performance ratings do not include the effects of aperturances (accessories).

NB: PF-WMX-HDE 90 710 is not licensed to bear the AMCA certified rating seal. The A-weighted sound ratings shown have been calculated per AMCA International Standard 301. Values shown are for outlet LwoA sound power levels for installation Type C: ducted inlet, free outlet.

Performance Curve

PF-WMX-SE30 800 PF-WMX-HE50 800 PF-WMX-HDE90 800

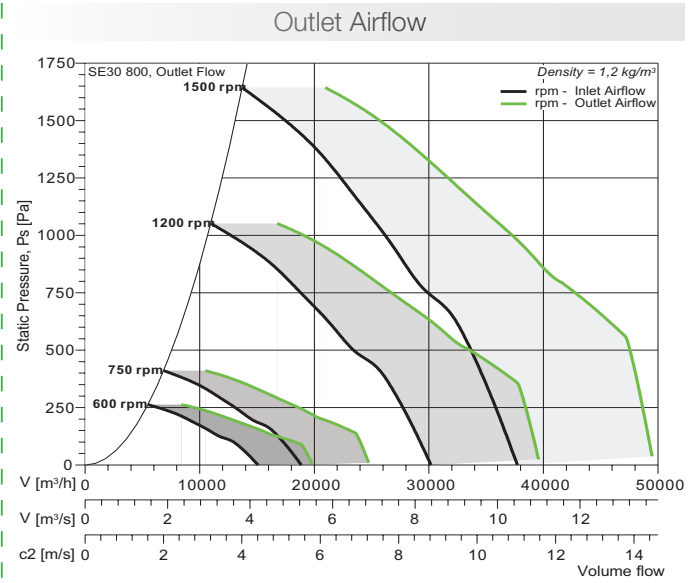
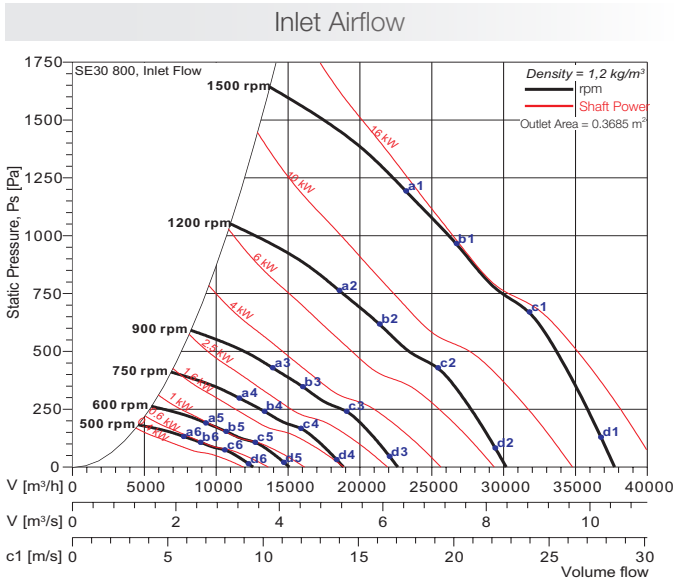

SE 30

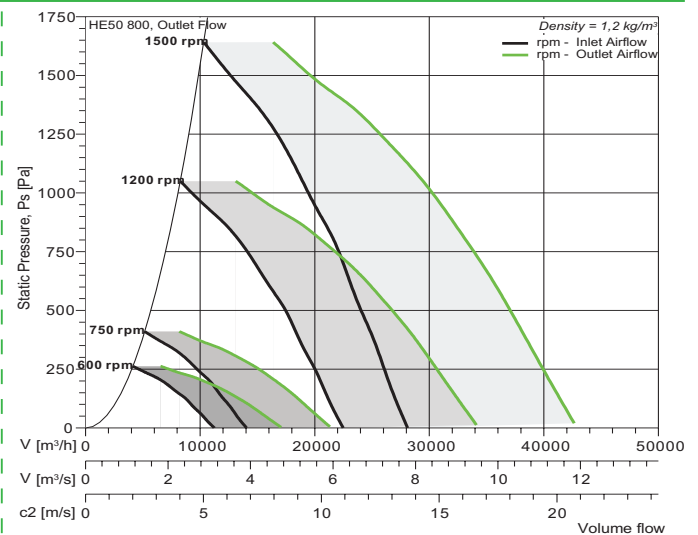
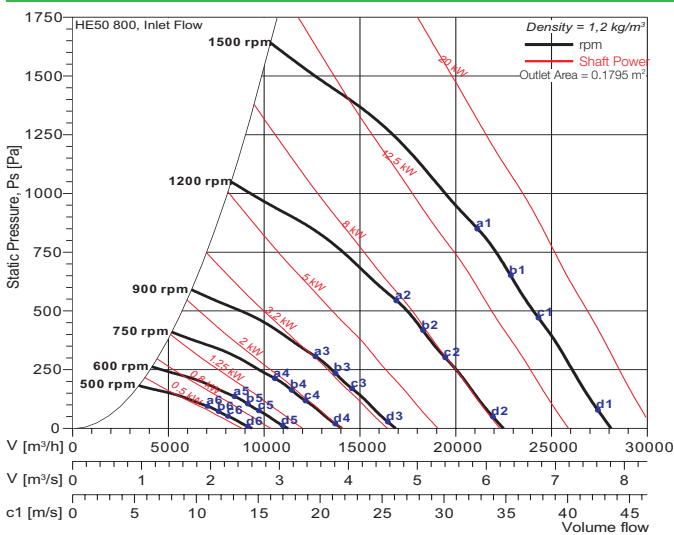

HE 50

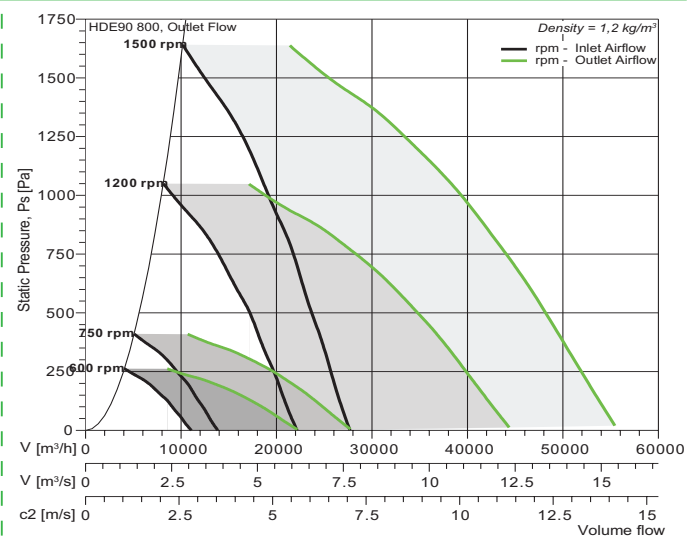
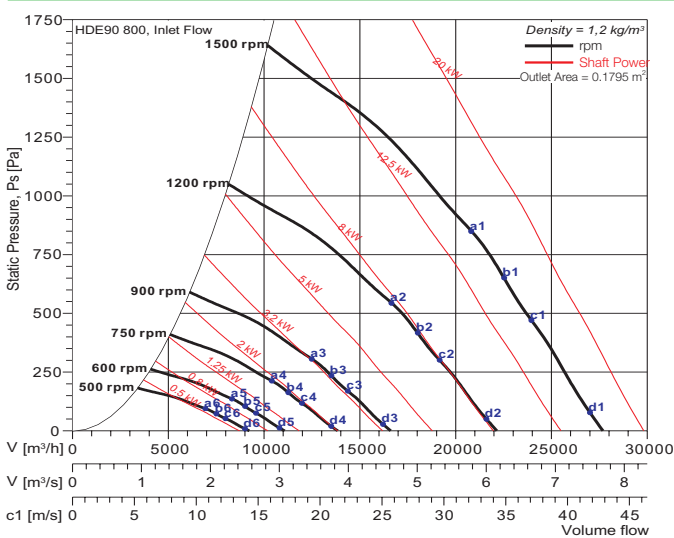

HDE 90 (non-AMCA)

The A-weighted Sound Power Levels

Lwo(A)	a1	b1	c1	d1	a2	b2	c2	d2	a3	b3	c3	d3	a4	b4	c4	d4	a5	b5	c5	d5	a6	b6	c6	d6
SE 30	93	95	96	99	87	89	90	93	80	81	83	86	75	76	78	81	69	70	72	75	63	65	67	70
HE 50	91	91	92	93	85	86	86	87	77	78	78	80	72	73	74	75	66	67	67	69	61	62	62	64
HDE 90	90	90	91	92	84	85	85	86	76	77	77	79	71	72	73	74	65	66	66	68	60	61	61	63

Fan test laboratory AMCA 210, 260 & 300. Performance certified is for installation type C - Ducted inlet, Free outlet. Power rating (kW) does not include transmission losses. Performance ratings do not include the effects of cross winds. Performance ratings do not include the effects of appurtenances (accessories).

NB: PF-WMX-HDE 90 800 is not licensed to bear the AMCA certified rating seal. The A-weighted sound ratings shown have been calculated per AMCA International Standard 301. Values shown are for outlet LwoA sound power levels for installation Type C: ducted inlet, free outlet.

Performance Curve

PF-WMX-SE30 900 PF-WMX-HE50 900 PF-WMX-HDE90 900



SE 30

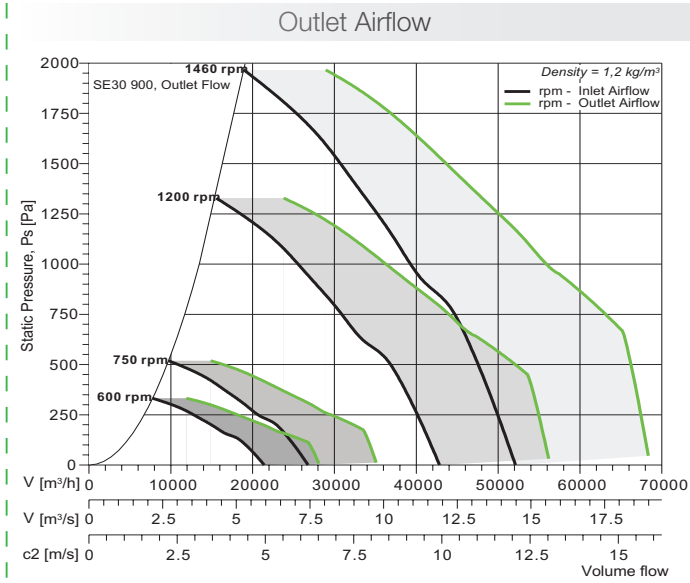
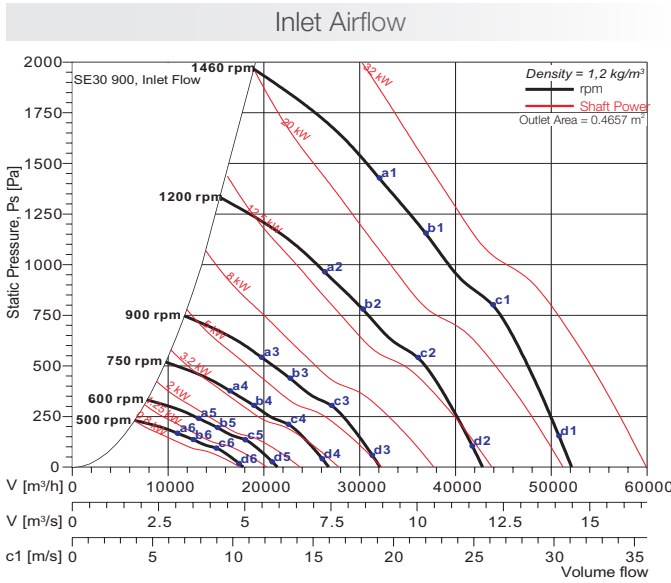

HE 50

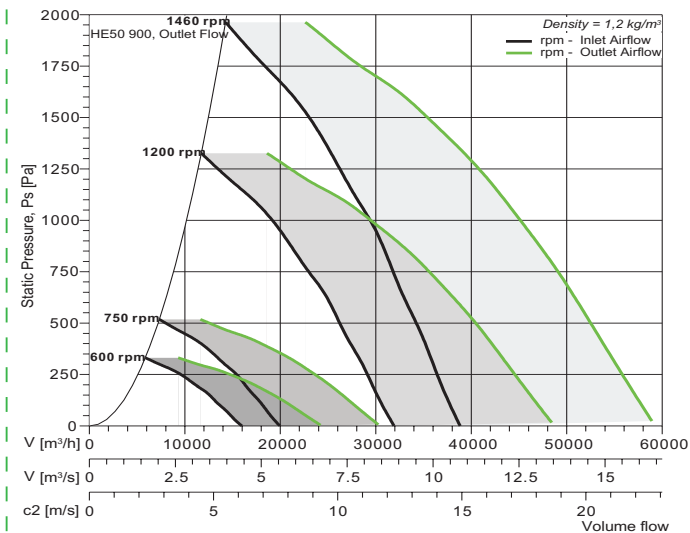
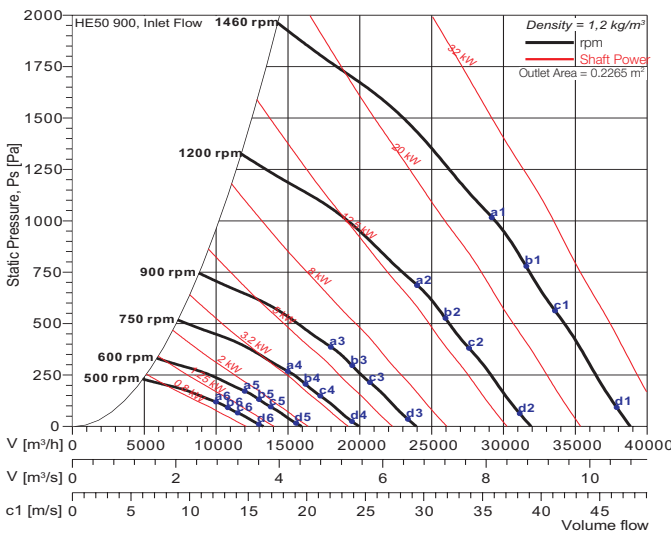

HDE 90 (non-AMCA)

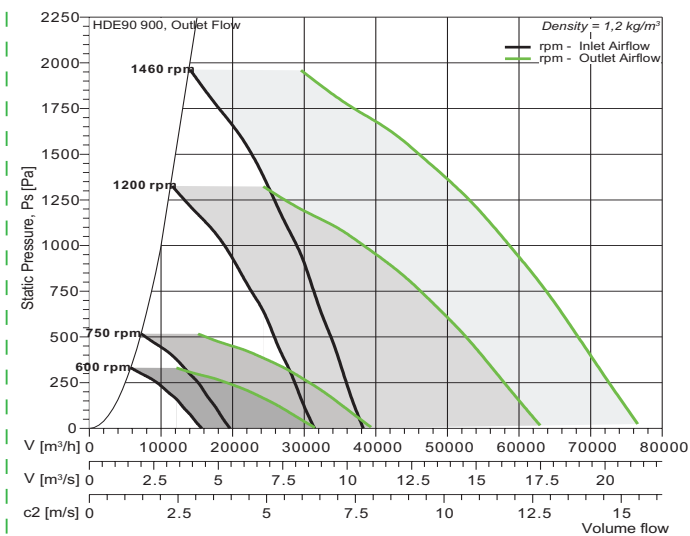
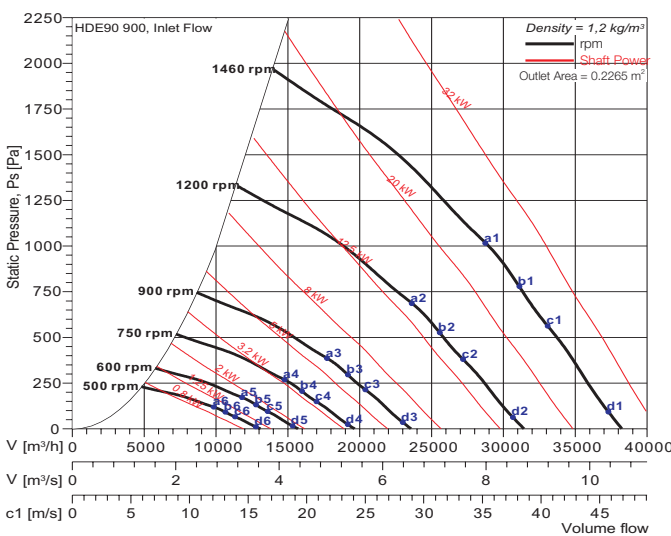

The A-weighted Sound Power Levels

Lwo(A)	a1	b1	c1	d1	a2	b2	c2	d2	a3	b3	c3	d3	a4	b4	c4	d4	a5	b5	c5	d5	a6	b6	c6	d6
SE 30	96	98	99	102	91	92	94	97	83	85	86	89	78	80	81	84	72	74	75	78	67	68	70	74
HE 50	94	94	95	96	88	89	90	91	81	81	81	83	76	76	77	78	70	70	71	72	65	65	66	67
HDE 90	93	93	94	95	87	88	89	90	80	80	81	82	75	75	76	77	69	69	70	71	64	64	65	66

Fan test laboratory AMCA 210, 260 & 300. Performance certified for installation type C - ducted inlet, Free outlet. Power rating (kW) does not include transmission losses. Performance ratings do not include the effects of cross winds. Performance ratings do not include the effects of apertures (accessories).

NB: PF-WMX-HDE 90 900 is not licensed to bear the AMCA certified rating seal. The A-weighted sound ratings shown have been calculated per AMCA International Standard 301. Values shown are for outlet LwoA sound power levels for installation Type C: ducted inlet, free outlet.

Performance Curve

PF-WMX-SE30 1000 PF-WMX-HE50 1000 PF-WMX-HDE90 1000

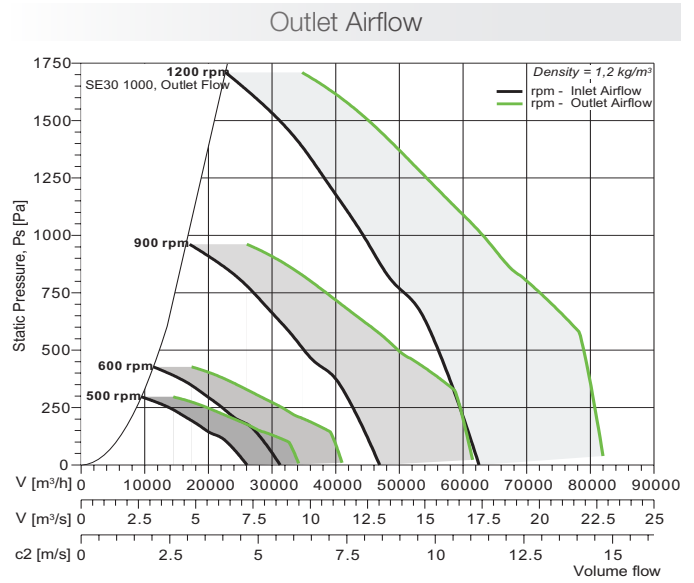
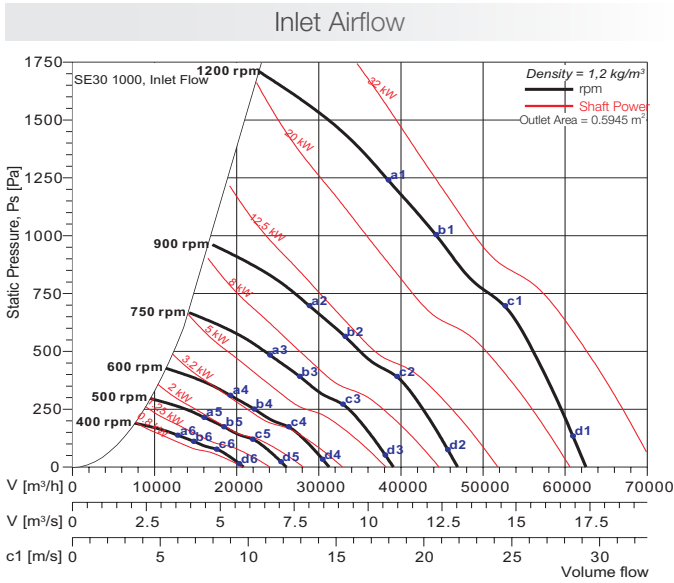

SE 30

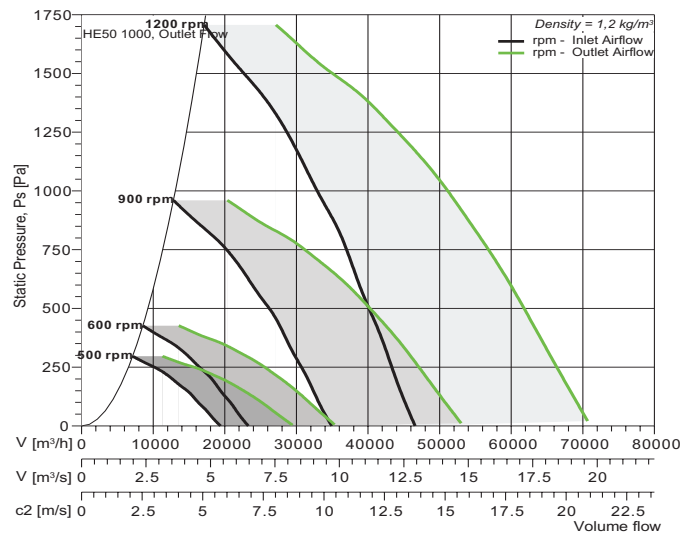
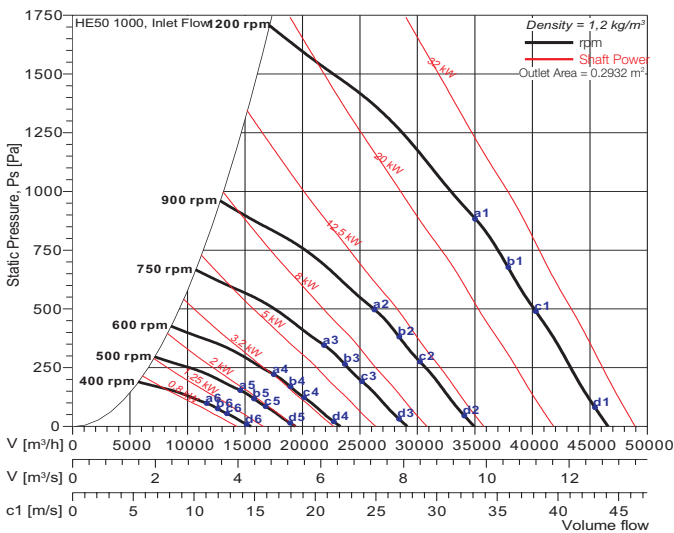

HE 50

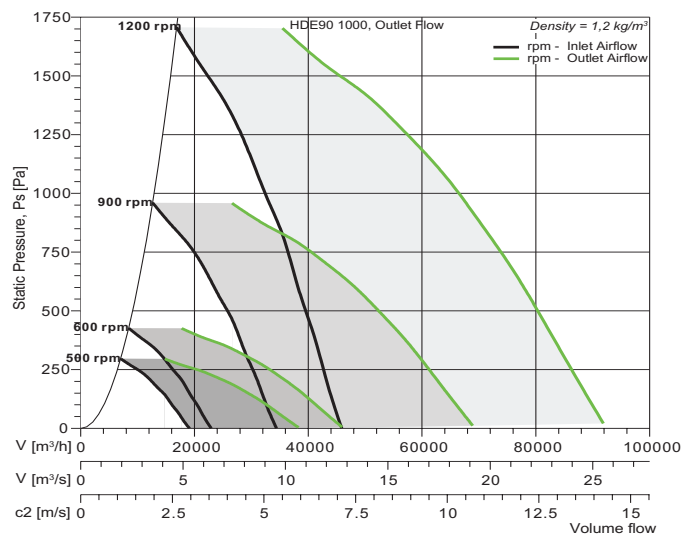
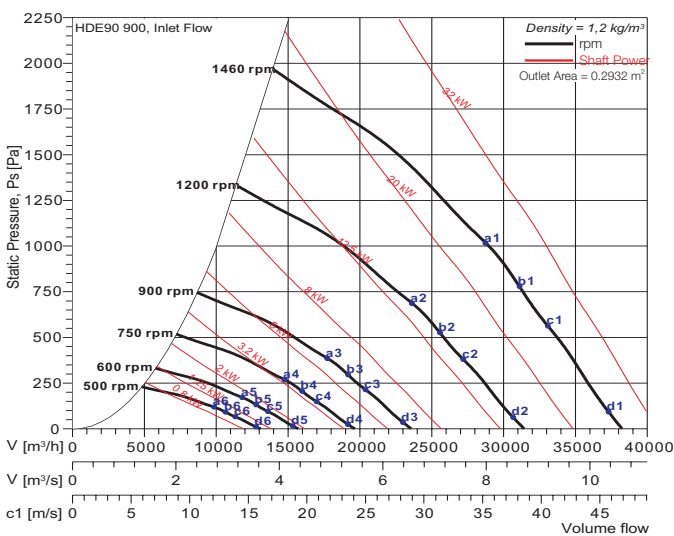

HDE 90 (non-AMCA)

The A-weighted Sound Power Levels

Lwo(A)	a1	b1	c1	d1	a2	b2	c2	d2	a3	b3	c3	d3	a4	b4	c4	d4	a5	b5	c5	d5	a6	b6	c6	d6
SE 30	95	96	98	100	87	88	90	93	82	84	85	88	76	77	79	82	71	72	74	77	65	66	68	71
HE 50	92	93	94	95	85	85	86	87	80	80	81	82	74	74	75	76	69	69	70	71	62	63	64	65
HDE 90	92	92	93	94	84	84	85	86	79	79	80	81	73	73	74	75	68	68	69	70	61	62	63	64

Fan test laboratory AMCA 210, 260 & 300. Performance certified for installation type C - Ducted inlet, Free outlet. Power rating (kW) does not include transmission losses. Performance ratings do not include the effects of cross winds. Performance ratings do not include the effects of appurtenances (accessories).

NB: PF-WMX-HDE 901000 is not licensed to bear the AMCA certified rating seal. The A-weighted sound ratings shown have been calculated per AMCA International Standard 301. Values shown are for outlet LwoA sound power levels for installation Type C: ducted inlet, free outlet.

Performance Curve

PF-WMX-SE30 1120
PF-WMX-HE50 1120
PF-WMX-HDE90 1120



SE 30

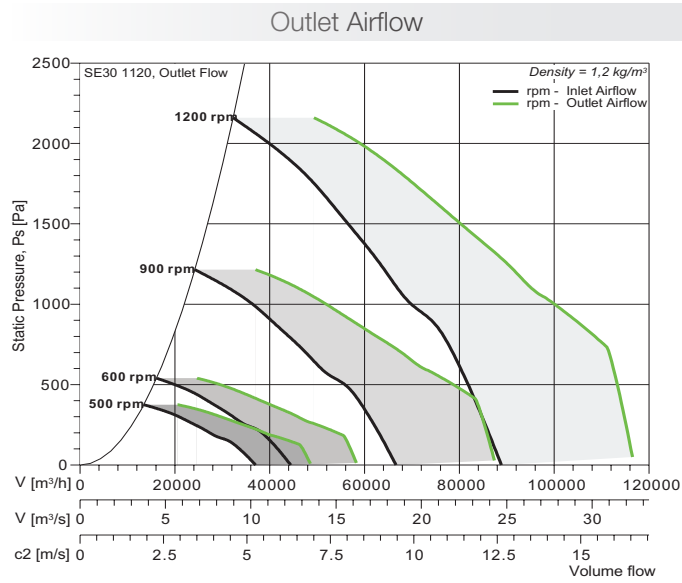
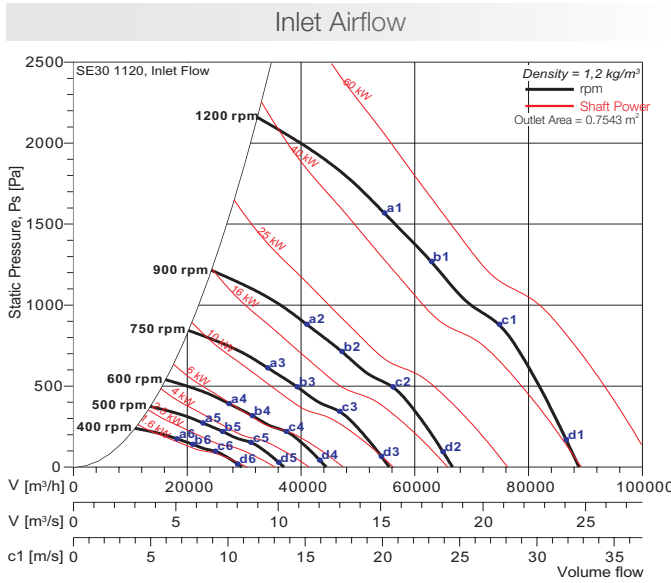

HE 50

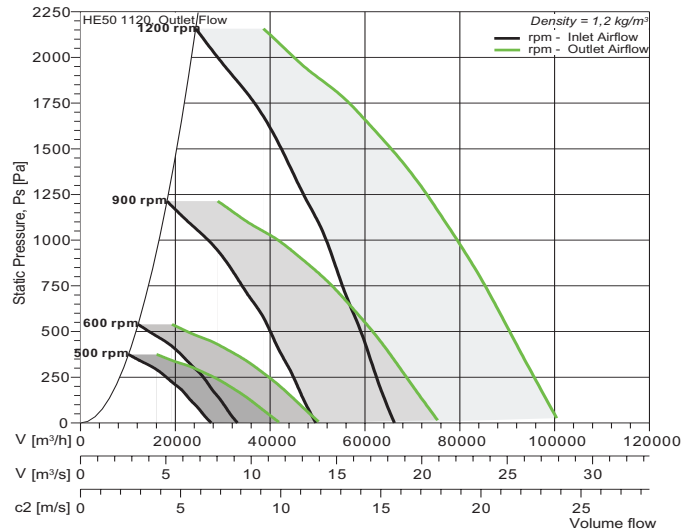
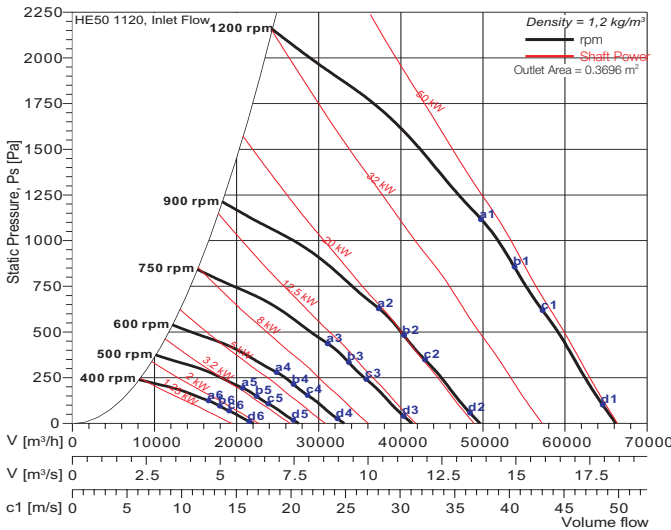

HDE 90 (non-AMCA)

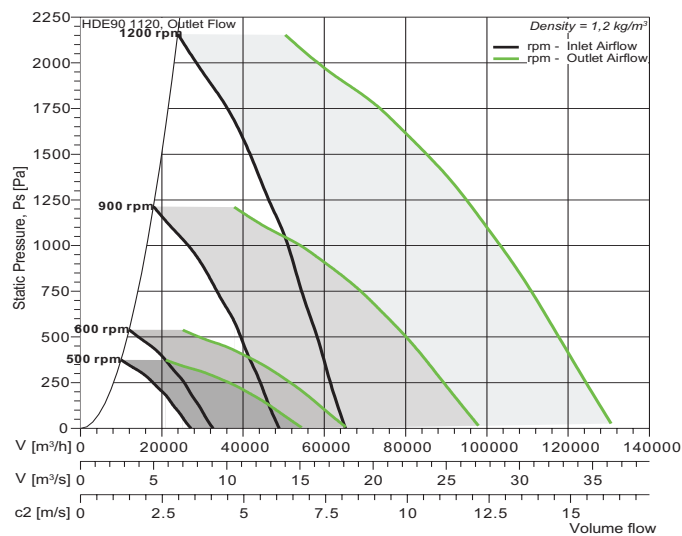
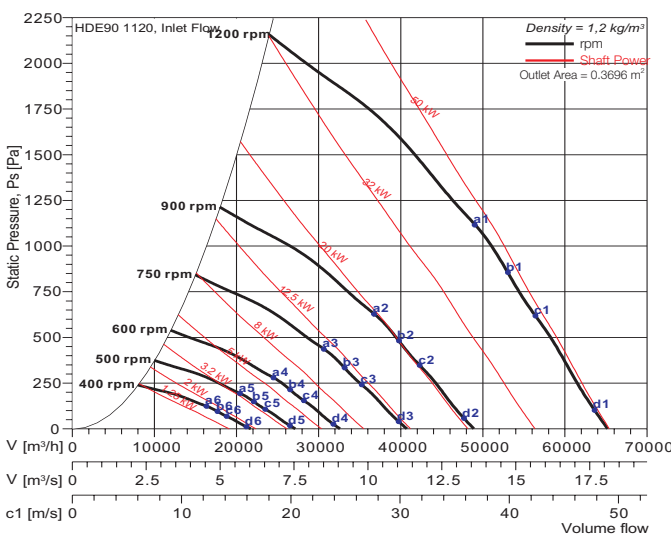

The A-weighted Sound Power Levels

Lwo(A)	a1	b1	c1	d1	a2	b2	c2	d2	a3	b3	c3	d3	a4	b4	c4	d4	a5	b5	c5	d5	a6	b6	c6	d6
SE 30	98	100	101	104	91	92	94	97	86	87	89	92	80	81	83	86	74	76	78	81	68	69	71	75
HE 50	96	96	97	98	88	89	89	91	83	84	84	86	77	78	78	80	72	73	73	75	66	67	67	68
HDE 90	95	96	96	97	87	88	88	90	82	83	83	85	76	77	77	79	71	72	72	74	65	66	66	67

Fan test laboratory AMCA 210, 260 & 300. Performance certified is for installation type C - Ducted inlet, Free outlet. Power rating (kW) does not include transmission losses. Performance ratings do not include the effects of cross winds. Performance ratings do not include the effects of apertures (accessories).

NB: PF-WMX-HDE 901120 is not licensed to bear the AMCA certified rating seal. The A-weighted sound ratings shown have been calculated per AMCA International Standard 301. Values shown are for outlet LwoA sound power levels for installation Type C: ducted inlet, free outlet.

Performance Curve

PF-WMX-SE30 1250 PF-WMX-HE50 1250 PF-WMX-HDE90 1250



Inlet Airflow

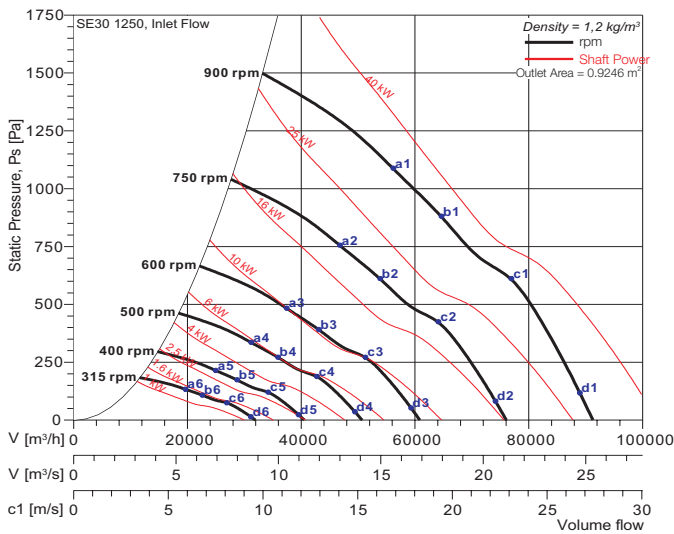

Outlet Airflow

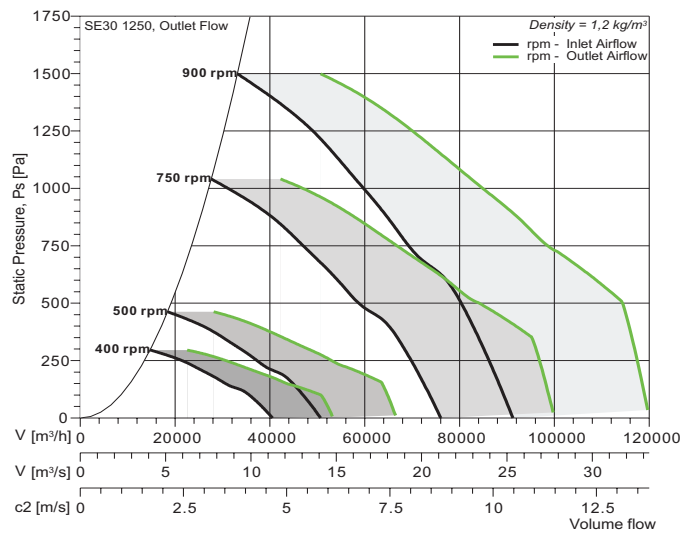

SE 30

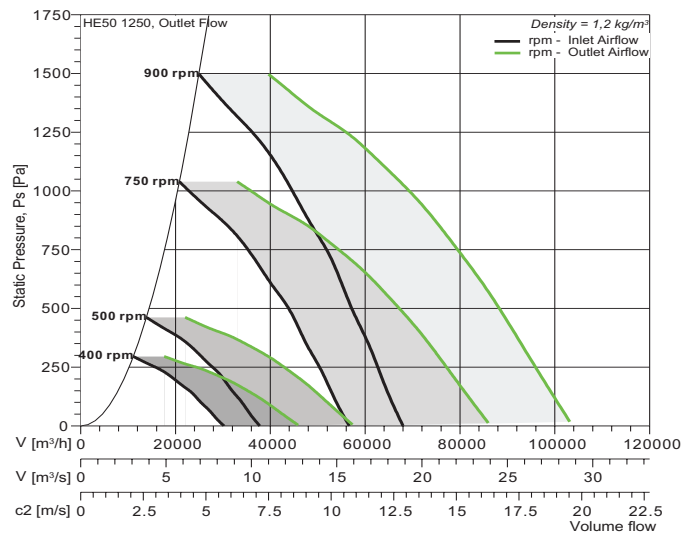
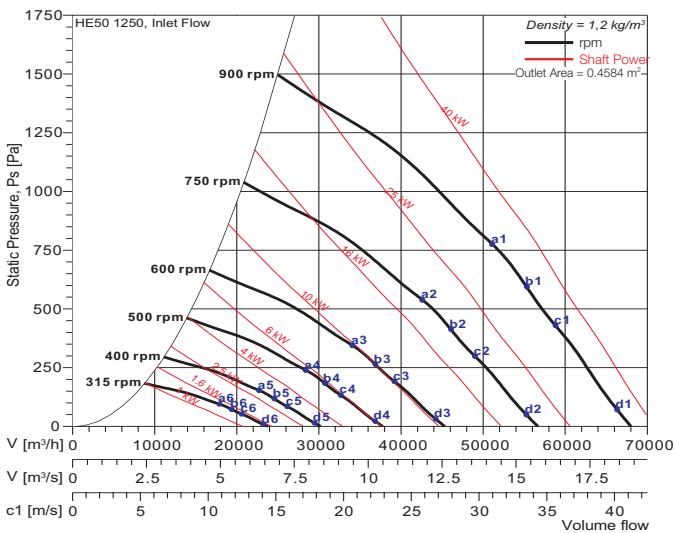

HE 50

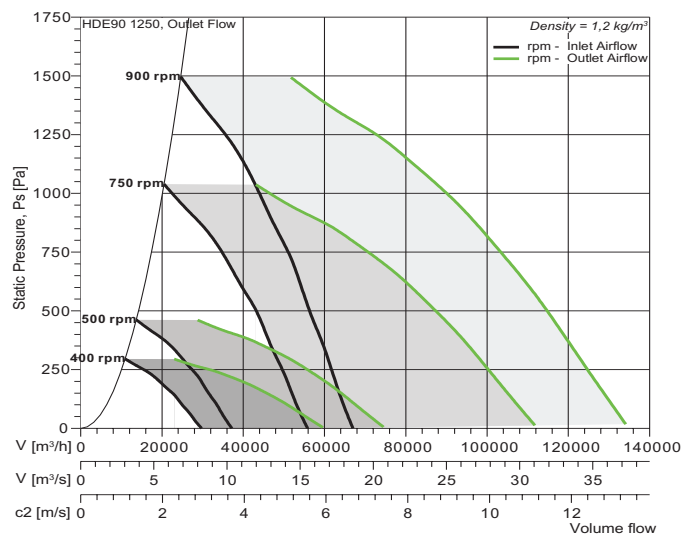
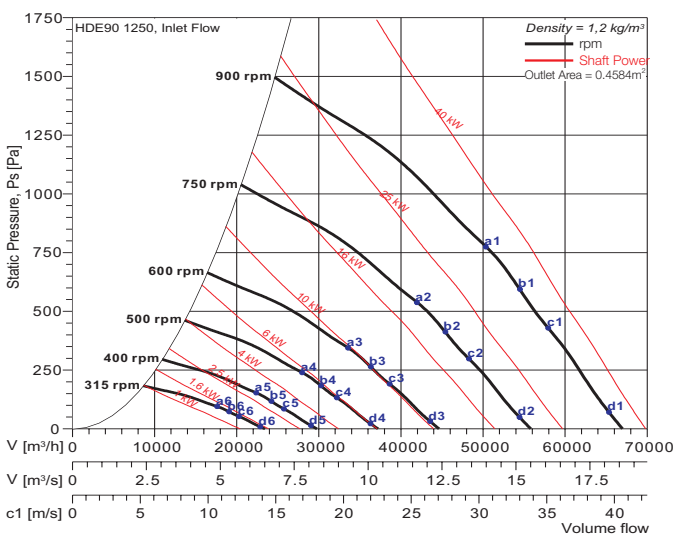

HDE 90 (non-AMCA)

The A-weighted Sound Power Levels

Lwo(A)	a1	b1	c1	d1	a2	b2	c2	d2	a3	b3	c3	d3	a4	b4	c4	d4	a5	b5	c5	d5	a6	b6	c6	d6
SE 30	94	95	97	100	89	90	92	95	83	84	86	89	78	79	81	84	71	73	75	78	65	66	68	71
HE 50	91	92	93	94	86	87	88	89	80	81	82	83	75	76	77	78	69	70	72	63	63	64	65	
HDE 90	91	91	92	93	85	86	87	88	79	80	81	82	75	75	76	77	68	69	71	62	62	63	64	

Fan test laboratory AMCA 210, 260 & 300. Performance certified for installation type C - Ducted inlet, Free outlet. Power rating (kW) does not include transmission losses. Performance ratings do not include the effects of cross winds. Performance ratings do not include the effects of appurtenances (accessories).

NB: PF-WMX-HDE 90 1250 is not licensed to bear the AMCA certified rating seal. The A-weighted sound ratings shown have been calculated per AMCA International Standard 301. Values shown are for outlet LwoA sound power levels for installation Type C: ducted inlet, free outlet.

Pressure Loss due to Jet Action (SE30 Type)
Fan Sizes 315 to 1250

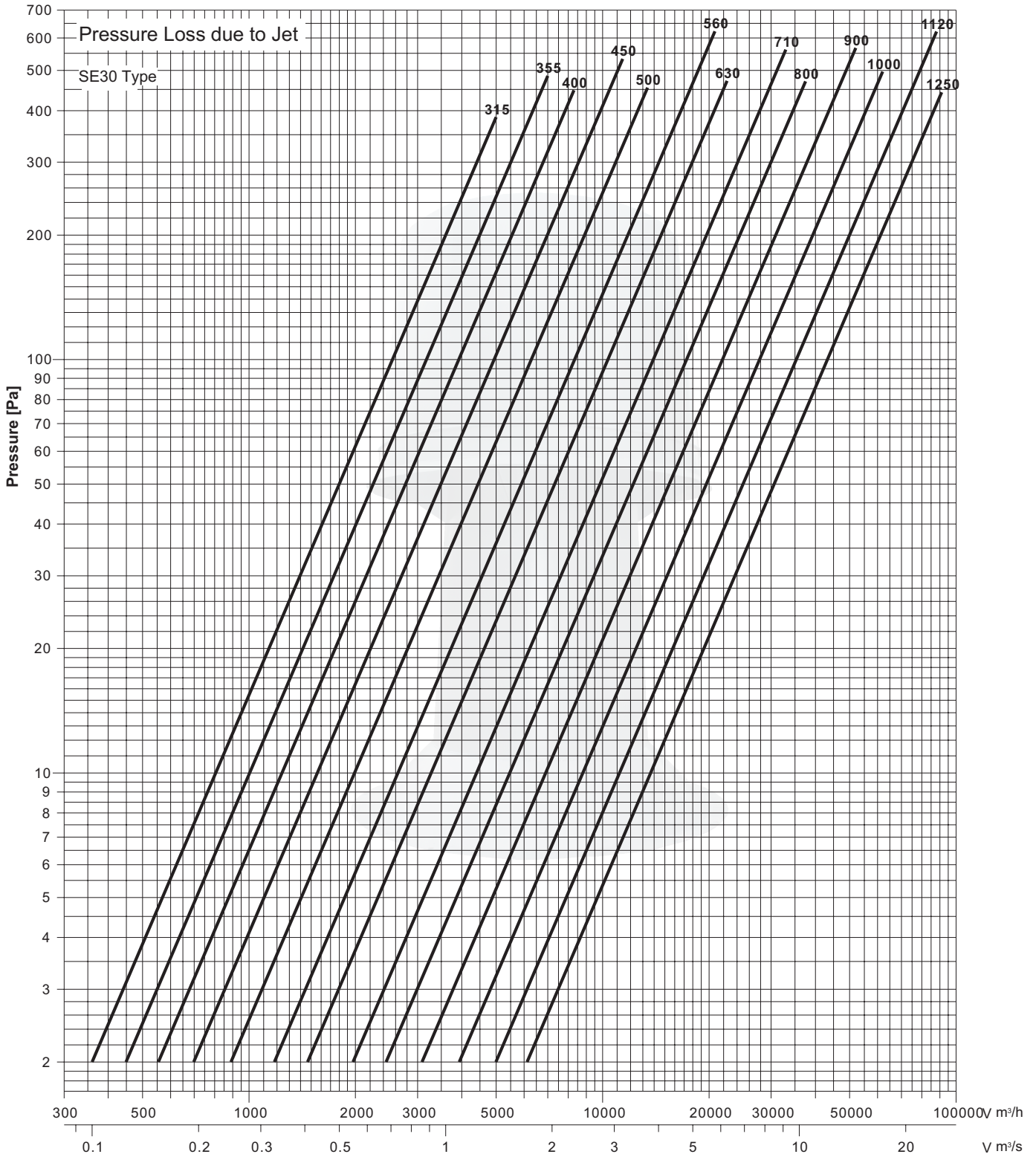

Pressure Loss due to Jet Action (HE50 / HDE90 Type)
Fan Sizes 315 to 1250

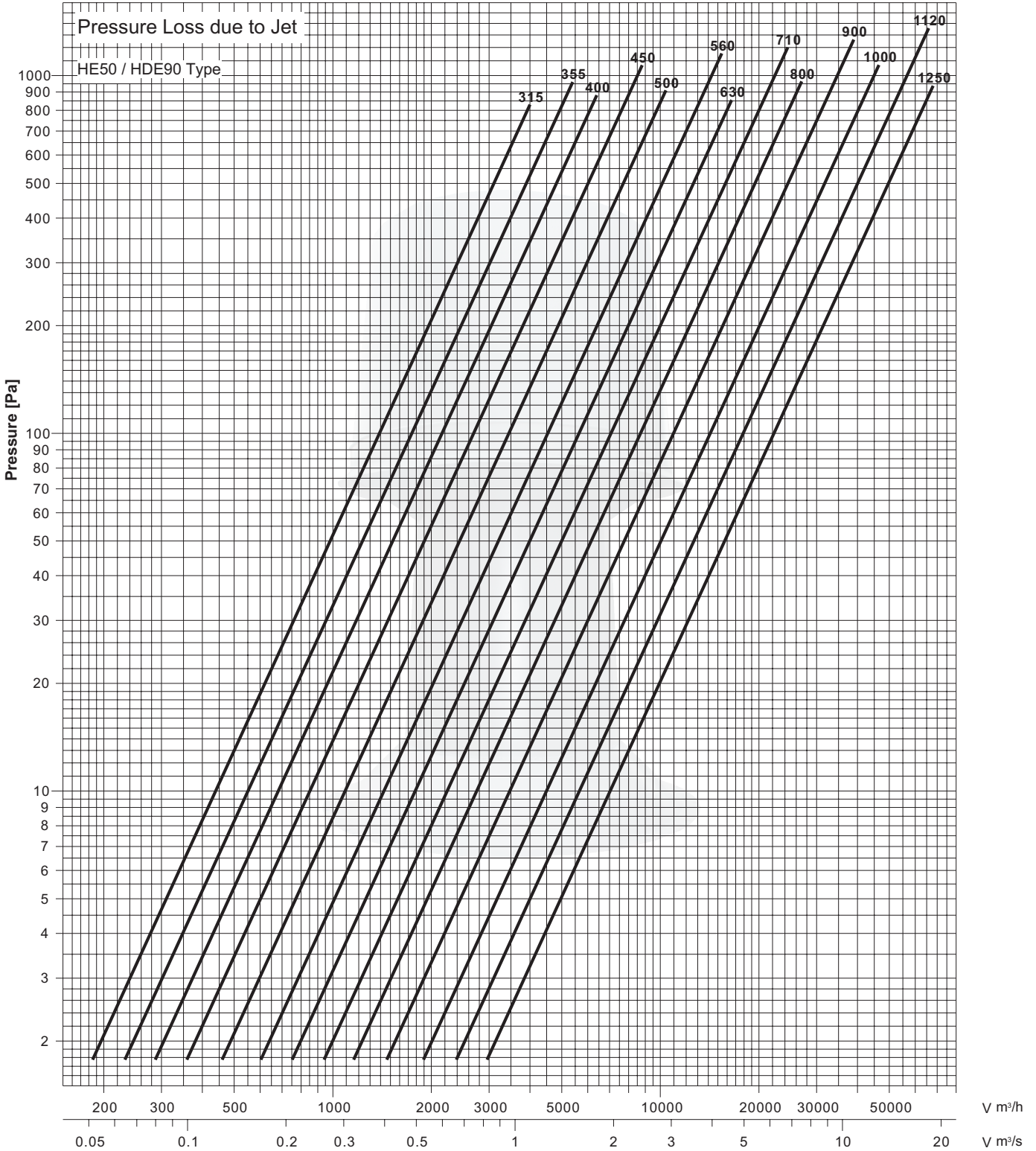

Effective Plume Rise h_r
 - SE30 Series, Fan Sizes 315 to 630

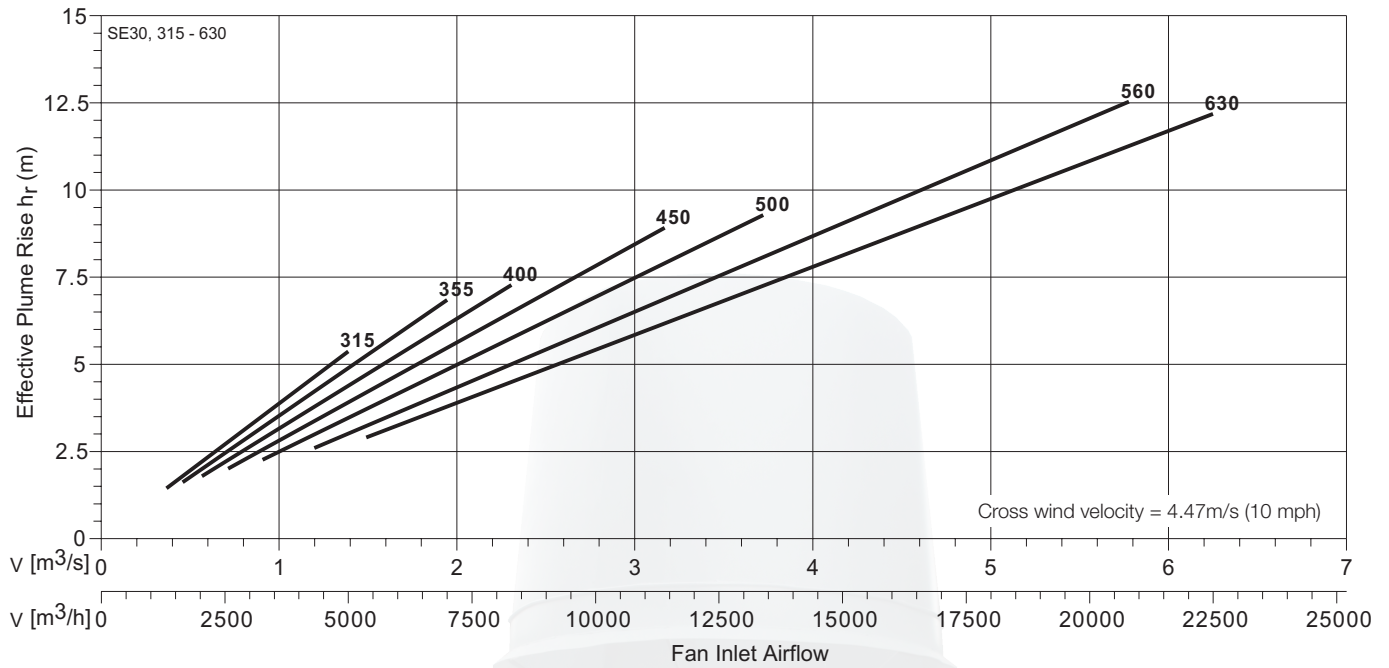

Effective Plume Rise h_r
 - SE30 Series, Fan Sizes 710 to 1250

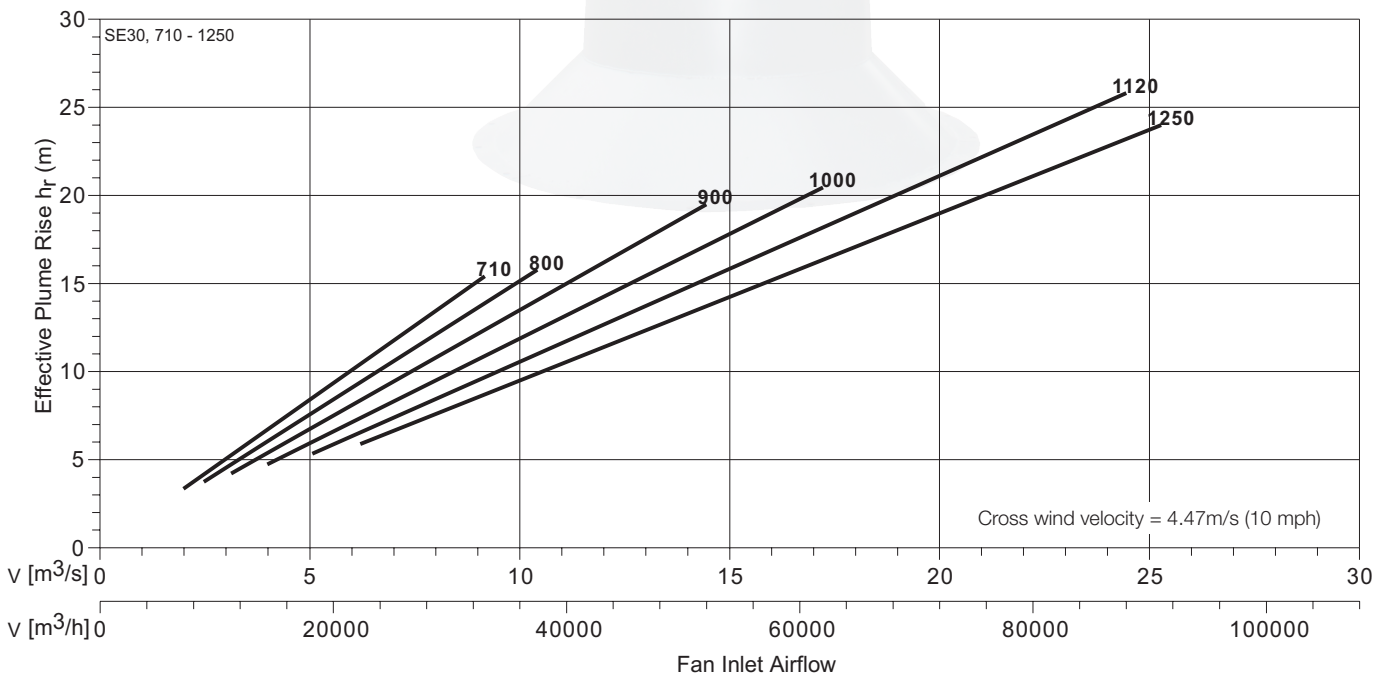

Effective Plume Rise h_r
 - HE50 Series, Fan Sizes 315 to 630

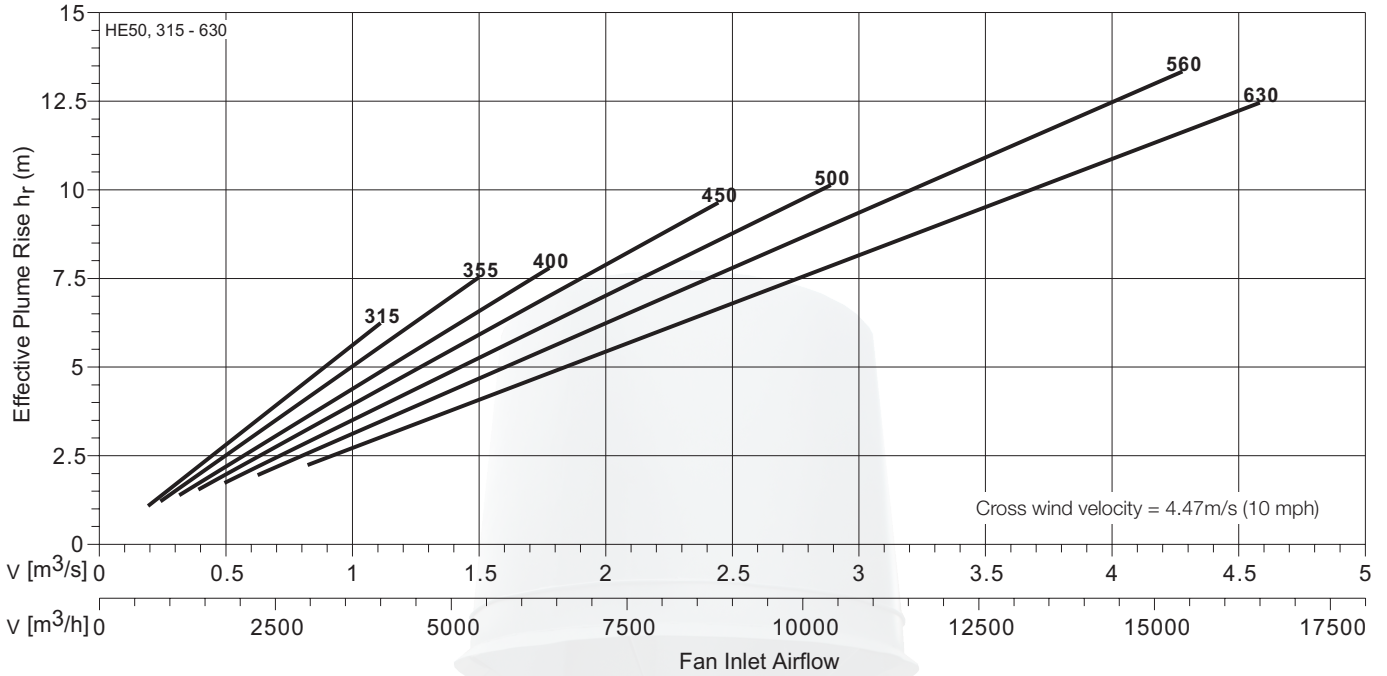

Effective Plume Rise h_r
 - HE50 Series, Fan Sizes 710 to 1250

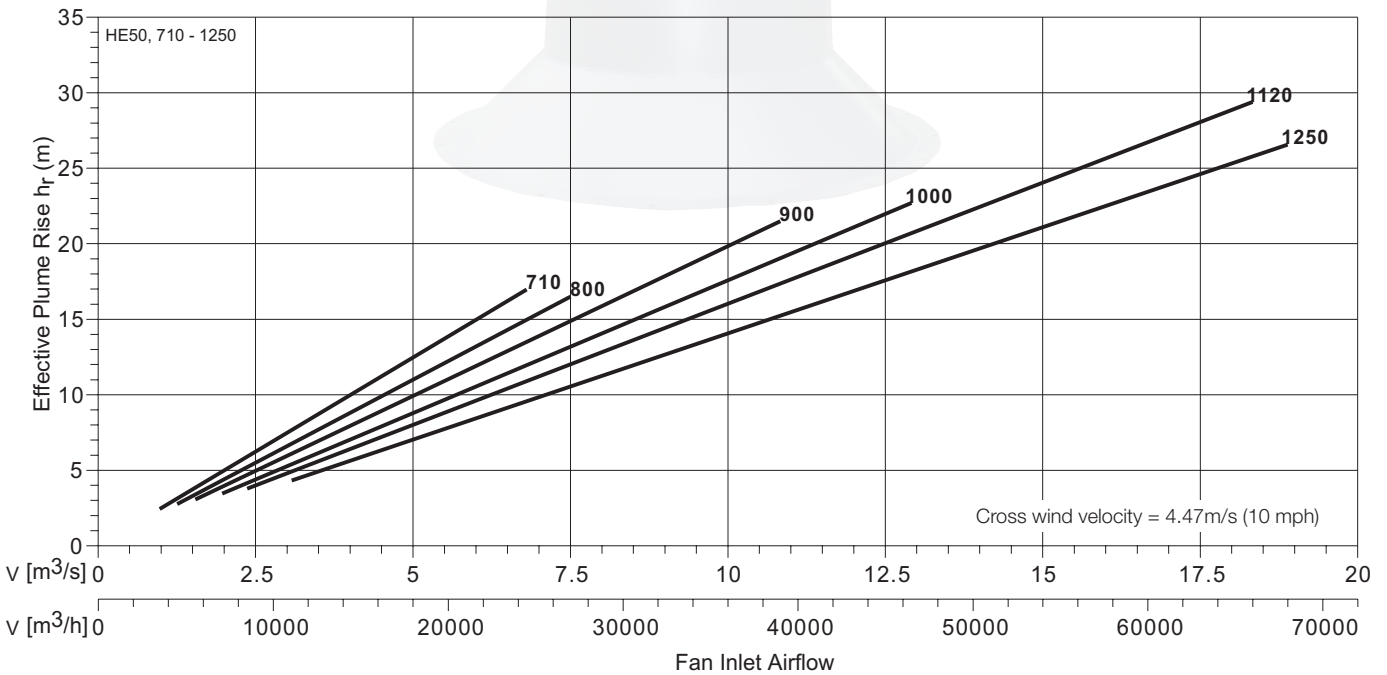

Effective Plume Rise h_r
 - HDE90 Series, Fan Sizes 315 to 630

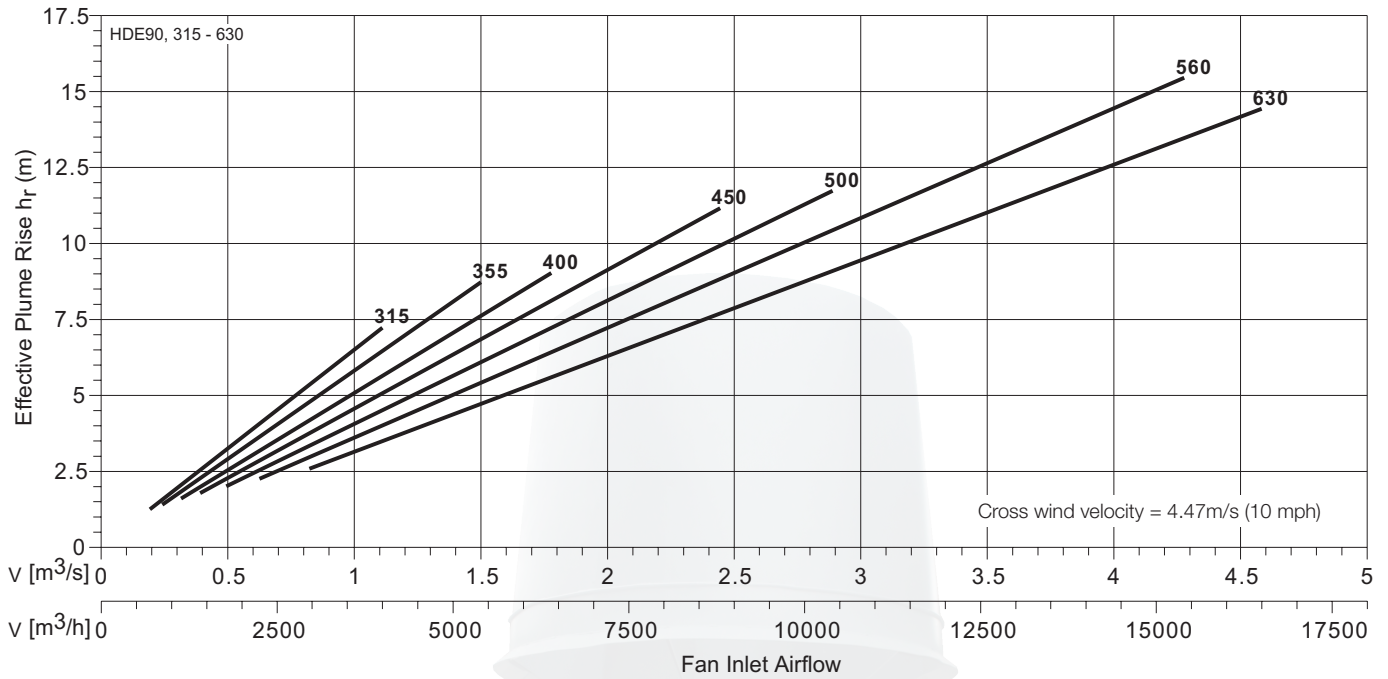

Effective Plume Rise h_r
 - HDE90 Series, Fan Sizes 710 to 1250

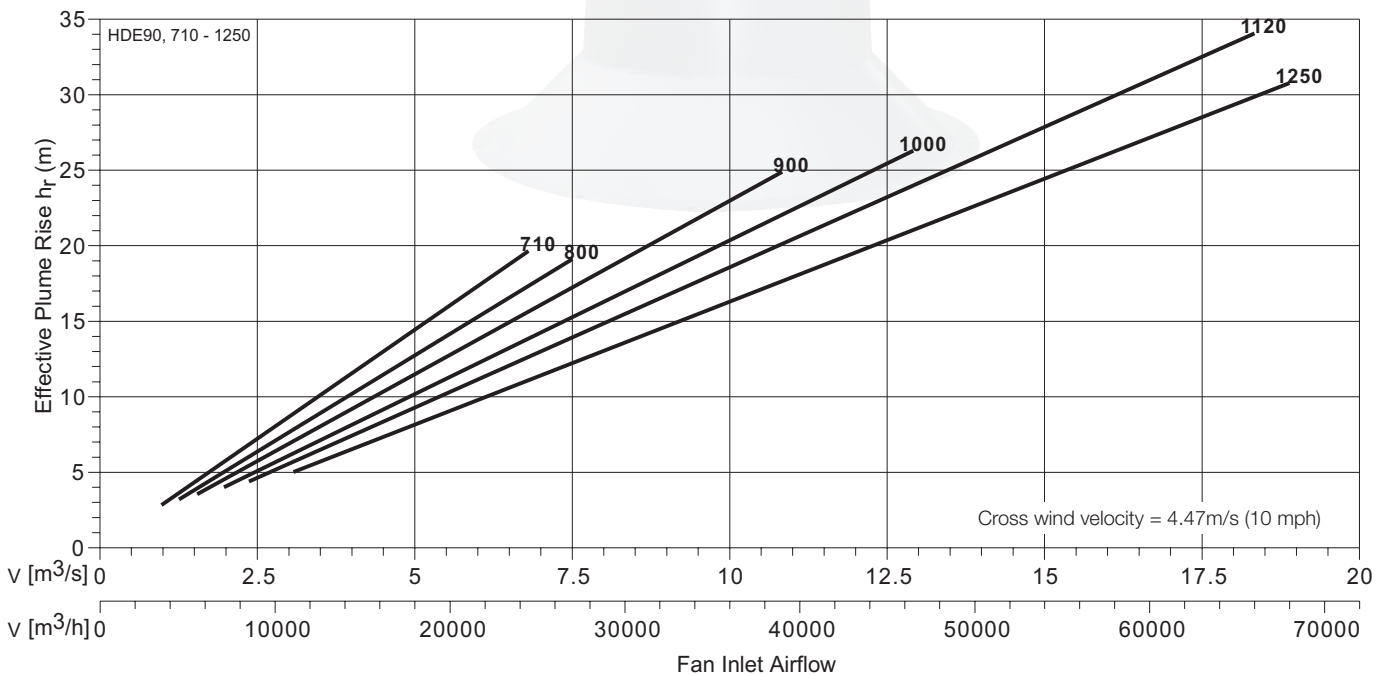

1FP Series

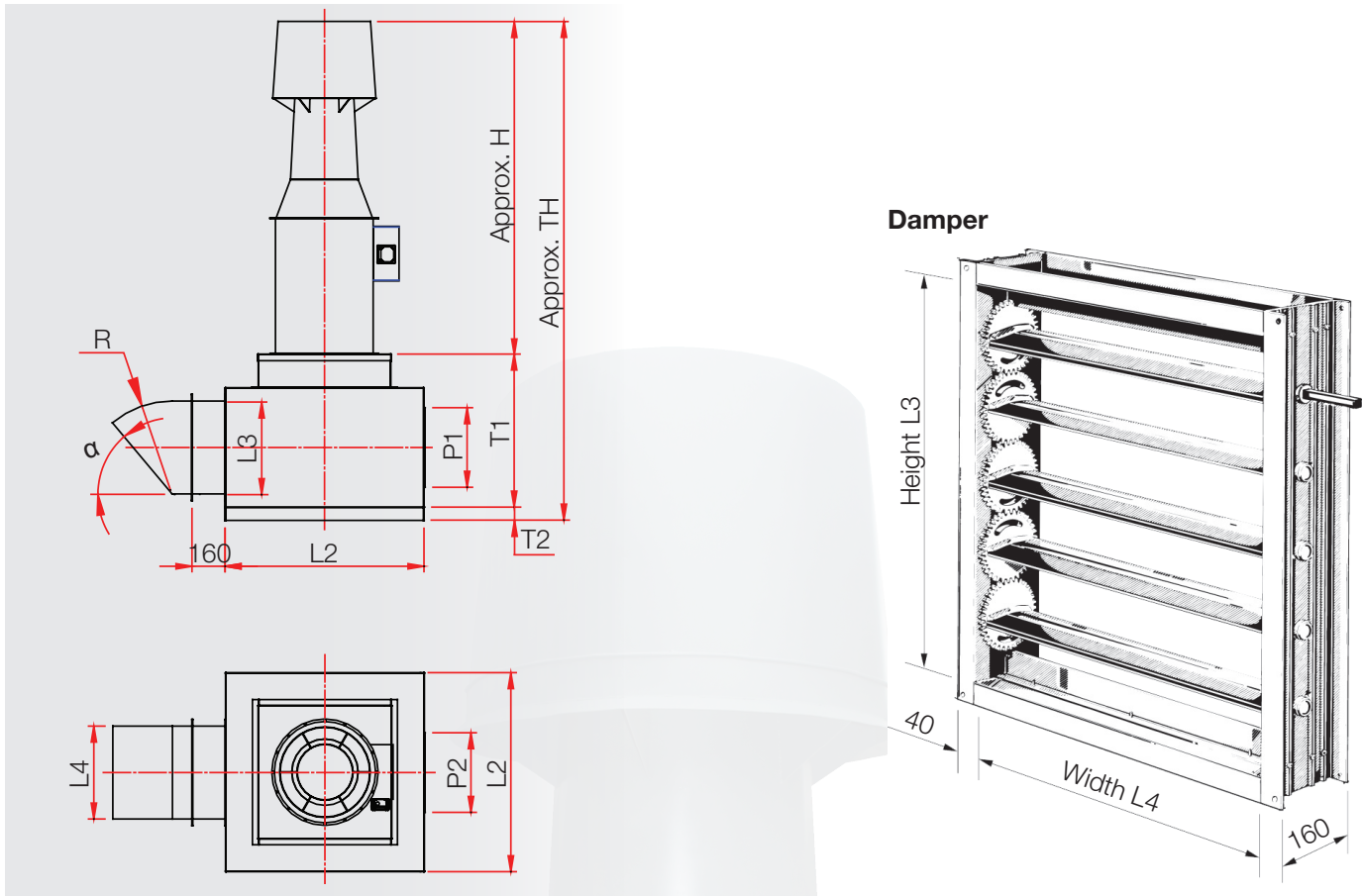

Various type of preferred plenum layout system

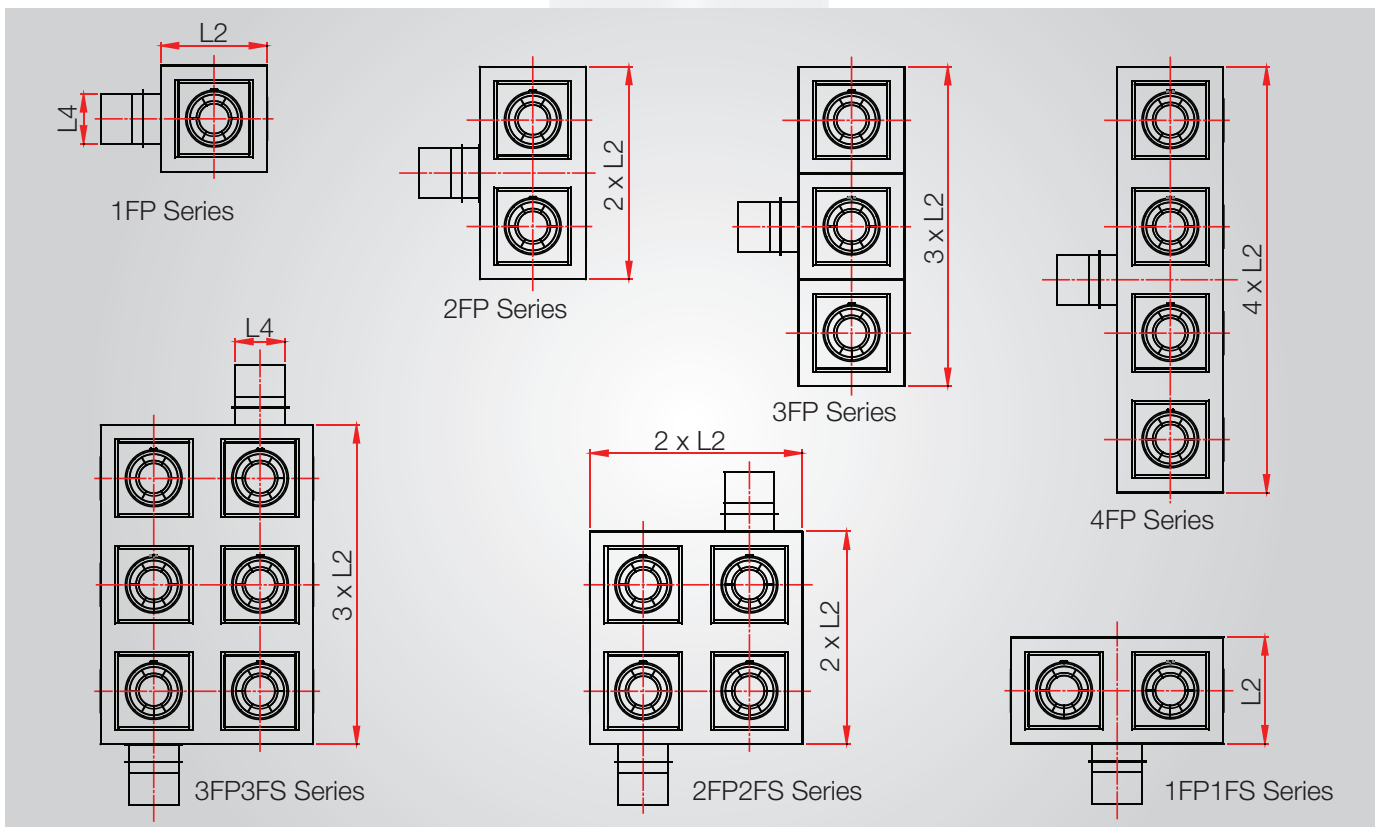

Fan Model	H(SE30)	H(HE50)	H(HDE90)	L2	L3	L4	Area*	P1
size	[mm]	[mm]	[mm]	[mm]	[mm]	[mm]	[m2]	[mm]
315	1703	1803	2130	1180	410	460	0.1584	400
355	1821	1922	2287	1180	410	460	0.1584	400
400	1942	2086	2504	1180	410	460	0.1584	400
450	2108	2230	2695	1490	510	460	0.1971	400
500	2255	2407	2930	1490	510	610	0.2613	400
560	2435	2608	3195	1490	510	700	0.2999	400
630	2639	2873	3547	1690	510	800	0.3427	400
710	2909	3061	3796	1690	510	1000	0.4284	400
800	3099	3361	4194	1840	610	1100	0.5636	400
900	3605	3841	4765	2200	710	1200	0.7157	400
1000	3890	4207	5250	2200	710	1500	0.8946	400
1120	4262	4515	5658	2550	1210	1300	1.3213	400
1250	4577	5008	6311	2550	1210	1350	1.3721	400

Fan Model	P2	R	α	T1	T2	TH(SE30)	TH(HE50)	TH(HDE90)
size	[mm]	[mm]	[°]	[mm]	[mm]	[mm]	[mm]	[mm]
315	390	460	30	810	270	2783	2883	3210
355	390	460	30	810	270	2901	3002	3367
400	390	460	30	810	270	3022	3166	3584
450	400	460	30	910	290	3308	3430	3895
500	400	610	30	910	290	3455	3607	4130
560	400	610	30	910	290	3635	3808	4395
630	400	760	30	910	290	3839	4073	4747
710	400	760	30	950	290	4149	4301	5036
800	400	910	30	1050	340	4489	4751	5584
900	400	1060	30	1160	350	5115	4351	6275
1000	400	1060	30	1160	350	5400	5717	6760
1120	400	1210	30	1690	400	6352	6605	7748
1250	400	1360	30	1690	400	6667	7098	8401

* Damper fully open area.

SE30 Series

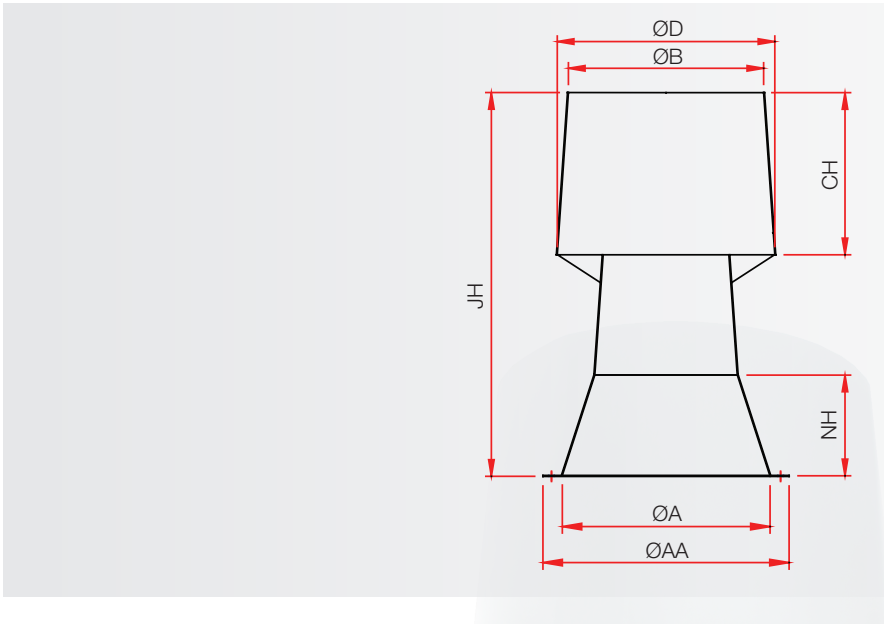

Fan model	AA	NN	A	N	B	D	CH	NH	JH	Fan Height
Size	[mm]	[mm]	[mm]	[mm]	[mm]	[mm]	[mm]	[mm]	[mm]	[mm]
315	584	-	504	-	424	474	352	177	903	800
355	664	-	565	-	480	535	398	201	1021	800
400	734	-	634	-	537	599	445	224	1142	800
450	814	-	711	-	615	686	510	257	1308	800
500	904	-	797	-	684	763	568	286	1455	800
560	1004	-	894	-	768	858	638	321	1635	800
630	1105	-	1003	-	864	965	717	361	1839	800
710	1245	-	1125	-	991	1106	823	659	2009	900
800	1370	-	1250	-	1081	1206	897	607	2079	1020
900	1525	-	1405	-	1224	1367	1016	787	2455	1150
1000	1725	-	1605	-	1358	1516	1127	689	2540	1350
1120	2010	-	1805	-	1533	1711	1273	673	2762	1500
1250	2210	-	2005	-	1681	1876	1395	637	2927	1650

HE50 Series

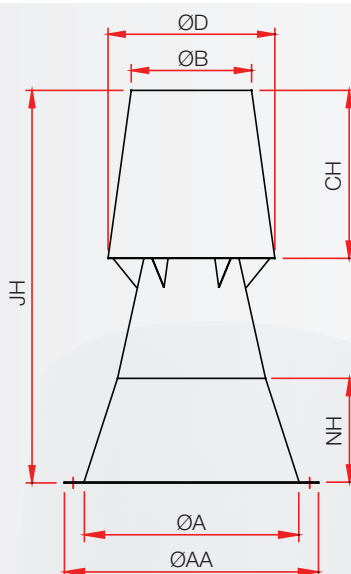

Fan model	AA	NN	A	N	B	D	CH	NH	JH	Fan Height
Size	[mm]	[mm]	[mm]	[mm]	[mm]	[mm]	[mm]	[mm]	[mm]	[mm]
315	584	-	504	-	342	453	400	161	1003	800
355	664	-	565	-	383	507	447	180	1122	800
400	734	-	634	-	439	580	512	206	1286	800
450	814	-	711	-	488	646	570	229	1430	800
500	904	-	797	-	548	726	640	258	1607	800
560	1004	-	894	-	617	816	720	290	1808	800
630	1105	-	1003	-	707	936	826	332	2073	800
710	1245	-	1125	-	771	1021	900	655	2161	900
800	1370	-	1250	-	873	1156	1020	635	2341	1020
900	1525	-	1405	-	969	1283	1131	799	2691	1150
1000	1725	-	1605	-	1094	1448	1277	721	2857	1350
1120	2010	-	1805	-	1199	1587	1400	673	3015	1500
1250	2210	-	2005	-	1367	1810	1596	688	3358	1650

HDE90 Series

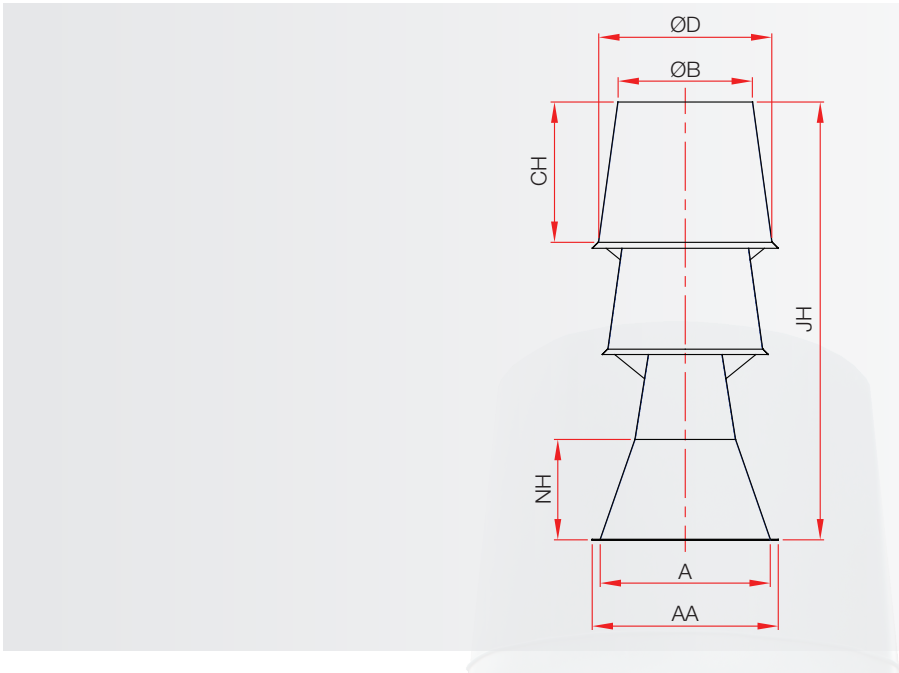

Fan model	AA	NN	A	N	B	D	CH	NH	JH	Fan Height
Size	[mm]	[mm]	[mm]	[mm]	[mm]	[mm]	[mm]	[mm]	[mm]	[mm]
315	584	-	504	-	394	508	412	161	1330	800
355	664	-	565	-	441	568	461	180	1487	800
400	734	-	634	-	505	651	528	206	1704	800
450	814	-	711	-	562	724	587	229	1895	800
500	904	-	797	-	631	814	660	258	2130	800
560	1004	-	894	-	710	915	742	290	2395	800
630	1105	-	1003	-	814	1050	851	332	2747	800
710	1245	-	1125	-	888	1145	928	655	2896	900
800	1370	-	1250	-	1005	1297	1051	635	3174	1020
900	1525	-	1405	-	1115	1439	1166	799	3615	1150
1000	1725	-	1605	-	1259	1624	1317	721	3900	1350
1120	2010	-	1805	-	1380	1780	1443	673	4158	1500
1250	2210	-	2005	-	1574	2030	1645	688	4661	1650

Sales Network

Deutschland

Wolter GmbH.
Maschinen-und Apparatebau KG.
DE-76316 Malsch
T +49 (0) 72 04 / 92 01 0
F +49 (0) 72 04 / 92 01 11
info@wolter.eu

Europe

Denmark:

L.ØLAND VENTILATION A/S
DK-2605 Brøndby
T +45 (0) 70 / 20 19 11
salg@airforce.dk

Netherlands:

DE WIT Ventilatoren BV
NL-3821 CG Amersfoort
T +31 (0) 33 / 76 00 240
info@dewitventilatoren.nl

Sweden:

Nordisk Ventilator AB
SE-142 50 Skogås
T +46 (0) 8 / 72 70 250
se@nordiskventilator.se

Switzerland:

Anson AG Zürich
CH-8055 Zürich
T +41 (0) 44 / 46 11 111
F +41 (0) 44 / 46 13 111
info@anson.ch

OZ Tech SA

CH-1122 Romanel-sur-Morges
T +41 (0) 76 / 41 11 572
info@oztech.ch

United Kingdom:

Wolter (UK) Ltd.
GB-Leicestershire LE65 1AL
T +44 (0) 15 30 / 41 24 73
info@wolteruk.com

Middle East

UAE, Saudi Arabia, Qatar, Lebanon:

Please contact Wolter head office

Wolter GmbH.

Maschinen-und Apparatebau KG.
DE-76316 Malsch
T +49 (0) 72 04 / 92 01 0
F +49 (0) 72 04 / 92 01 11
info@wolter.eu

Asia

China:

Guangdong Wolter Chemco Ventilation Ltd.
Boluo, Huizhou, Guangdong

Dongguan Wolter Chemco Ventilation Ltd.

Shipai, Dongguan, Guangdong
T +86 (0) 769 / 8655 7298
F +86 (0) 769 / 8655 7278
info@wolter.com.hk

Taizhou Wolter Ventilation Co. Ltd.

Hengjie, Luqiao District,
Taizhou, Zhejiang
T +86 (0) 576 / 26 22 666 (26 52 888)
F +86 (0) 576 / 26 56 830

China - Hong Kong, Macau:

Wolter Asia Ltd
Kowloon, Hong Kong
T +852 (0) 2456 0198
F +852 (0) 2456 0290
info@wolter.com.hk

China - Taiwan:

Waxlink International Co., Ltd.
8F-2 No.218 Roosevelt Rd.,
Sec.6, Taipei, Taiwan
T +886 (0) 2 / 8932 1196
F +886 (0) 2 / 8932 1197
waxlink@mail.waxlinktw.com

India:

Wolter Ventilators India Pvt. Ltd.
867 D, Block-A, Sushant Lok, Phase-I,
Gurgaon - 122009 (Haryana)
T +91 (0) 124 2577797, 4261001-3
sales@wolterindia.in

Korea:

Kaceco-Wolter
14-1, Dang-dong, Gunpo-shi,
Gyeonggi-do
T +(82) 0 31 / 4773 104
F +(82) 0 31 / 4773 132
wolter@kaceco.com
info@kaceco.com

Malaysia:

Vibrantech (M) Sdn Bhd.
47200 Petaling Jaya Selangor
T +603 (0) 7847 3500
F +603 (0) 7847 3380
sales@vibrantech-sb.com

Singapore:

Wolter Pte. Ltd.
SG-569738 Singapore
T +65 (0) 63 / 52 95 48
F +65 (0) 63 / 52 95 47
info@wolterfans.com.sg

Thailand:

Wolter Ventilation Co., Ltd.
Thamai Kratumban Samutsakorn
741 10 Thailand
T +66 (0) 84 555 2936
kongsakol@wolterfan.com

Australia

The Sydney Fan Company.
NSW 2147, Sydney, Australia
T +61 (0) 2 / 9624 4000
F +61 (0) 2 / 9624 4100
sales@thesydneyfancompany.com

Wolter GmbH Maschinen-und Apparatebau KG

Am Wasen 11
DE-76316 Malsch / Germany
T +49 (0) 72 04 / 92 01 0
F +49 (0) 72 04 / 92 01 11
www.wolter.eu
info@wolter.eu





Reference: **R10.4**, V2017/August, Printed in August, 2017